

**KERAJAAN MALAYSIA**

**A GUIDE TO THE DESIGN  
OF TRAFFIC SIGNAL**

©2017 Jabatan Kerja Raya Malaysia.  
Hak Cipta Terpelihara.

Tidak dibenarkan mengeluarkan mana-mana bahagian artikel, ilustrasi dan isi kandungan buku ini dalam apa jua bentuk dan dengan apa jua cara sama ada secara elektronik, mekanikal, salinan, rakaman atau cara lain sebelum mendapat keizinan bertulis daripada penerbit.

A Guide To The Design  
of Traffic Signal



Jabatan Kerja Raya  
Cawangan Jalan

ATJ 13/87 (Pindaan 2017)

A GUIDE TO THE DESIGN OF TRAFFIC SIGNAL



Ketua Pengarah Kerja Raya  
Jabatan Kerja Raya Malaysia  
Jalan Sultan Salahuddin  
50582 Kuala Lumpur

## FOREWORD

This Arahan Teknik (Jalan) on “ A Guide to the Design of Traffic Signal” is to be used for the design of signalized intersection in conjunction with Arahan Teknik (Jalan) 11/87 – A Guide to the Design of At-Grade Intersection and other relevan Arahan Teknik. This guideline presents fundamental concepts and practices related to traffic signal design that are to be adopted.

This Arahan Teknik (Jalan) ATJ 13/87 (PINDAAN 2017), A Guide to the Design of Traffic Signal, is the revision of the existing Arahan Teknik (Jalan) 13/87 which was published in 1987. The designer encouraged to study Malaysian Highway Capacity Manual (MHCM, 2006) together with this Arahan Teknik to fully understand the concepts and approaches adopted in this guideline.

The preparation of this guideline was carried out through many discussion held by the committee members. Feedbacks and comments received were carefully considered and incorporated into this guideline wherever appropriate.

This guideline will be reviewed and updated from time to time to cater for and incorporate the latest development in road geometric design. Any comment and feedback regarding this guideline should be forwarded to Unit Standard, Bahagian Pembangunan Inovasi & Standard, Cawangan Jalan, JKR.

Published by: -

Cawangan Jalan  
Ibu Pejabat Jabatan Kerja Raya Malaysia  
Tingkat 21, Menara PJD  
No. 50, Jalan Tun Razak  
50400 Kuala Lumpur  
Email: [ussj.jkr@1govuc.gov.my](mailto:ussj.jkr@1govuc.gov.my)

## ACKNOWLEDGEMENT

This ATJ 13/87 (Pindaan 2017) was prepared by a working committee comprising of the following members:

Ir. Mohamad Sharip Bin Wahijan (Chairman)	JKR
En. Shahrul Nizam Bin Siajam	JKR
Ir. Fatimah Nuri Binti Mohd Yusof	JKR
Pn. Noor Aziah Binti Tarmizi	JKR
Pn. Ang Yee Wen	JKR
En. Mohamad Hafzan Bin Abd Aziz	JKR
Pn. Wan Rifhan Binti Wan Ab Rahim	JKR
Ir. Mohd Firdaus Bin Ismail	JKR
Ir. Mohamad Ashari Bin Muda	KKR
Ir. Ravi Shankar Ayappan	Consultant
Dr. Aminuddin bin Ahmad Kayani	Consultant

The publisher would like to express its utmost appreciation to the above committee members for their valuable contributions towards the successful completion of this document.

The Working Committee also would like to thank the following personnels for their contribution and idea during the working committee workshop and course related to this ATJ: -

Ir. Hj. Abdul Rahman Bin Baharuddin	JKR
Pn. Noorfadzilah binti Ramlee	JKR
Pn. Khadijah binti Basar	JKR
En. Ng Chee Keong	JKR
Pn. Rosmawati binti Abdul Razak	JKR
Prof. Dr. Wan Hashim Wan Ibrahim	UNIMAS
Assoc. Prof Ir. Dr. Leong Lee Vien	USM
En. Saiful Annuar bin A. Majid	Consultant

A special thanks to Dato'. Ir. Dr. Meor Aziz Osman, Deputy Director General of Works (Infra Sector), Ir. Zulakmal bin Haji Sufian, Senior Director of Road Branch, Dato' Ir. Hj. Che Noor Azeman bin Yusoff, Director of Road and Bridge Design, Ir. Dr. Lim Char Ching, Director of Forensics Engineering and Technical Support Division, *Cawangan Jalan, Jabatan Kerja Raya Malaysia* for their support and contribution towards the successful completion of this specification.

## CONTENTS

	<b>Page</b>
<b>FOREWORD</b>	i
<b>ACKNOWLEDGEMENT</b>	ii
<b>1.0 INTRODUCTION</b>	<b>1</b>
1.1 Objectives of Traffic Signal Control	1
1.2 Advantages and Disadvantages of Signal Control	1
<b>2.0 SIGNAL INSTALLATION CRITERIA</b>	<b>3</b>
2.1 General	3
2.2 Warrant Analysis	4
2.2.1 Warrant No. 1: 8-Hour Volume	4
2.2.2 Warrant No. 2: Peak Hour / 1-Hour Volume	5
2.2.3 Warrant No. 3: Coordinated Signal System	6
2.2.4 Warrant No. 4: Pedestrian Safety	7
2.2.5 Warrant No. 5: Accident Experience	8
<b>3.0 SIGNAL OPERATION REQUIREMENTS</b>	<b>9</b>
3.1 Phasing Elements	9
3.1.1 Two Phase (3-Legged Junction)	9
3.1.2 Multi Phase (3-Legged & 4-Legged Junction)	10
3.2 Right-Turn Phasing	14
3.3 Suggested Guidelines for Separate Right-Turn Phases	15
3.4 Selection of Fixed Time or Actuation Signal	16
3.4.1 Fixed Time Signal	16
3.4.2 Vehicle Actuated Signals	17
3.4.3 Traffic-adjusted System	17
3.4.4 Comparison of Fixed Time and Vehicle Actuated Control	17
3.5 Digital Countdown	19
3.5.1 Fixed/Multiplan Countdown	19
3.5.2 VA (Vehicle Actuated) Countdown	20
3.5.3 VA (Vehicle Actuated) Jump Countdown	20
3.5.4 Countdown in Amber Aspect	20
<b>4.0 SIGNAL HEAD AND LOCATION</b>	<b>21</b>
4.1 Signal Head Requirements	21
4.1.1 Minimum Visibility Requirements	21
4.2 Number and Location of Signal Head	22
4.2.1 Cone of Vision	23
4.2.2 Height of Signal Head	23
4.2.3 Designation and Function	24
4.2.4 Other Location Criteria	25

## CONTENTS

	<b>Page</b>	
4.3	Number of Signal Aspects Per Signal Head	25
4.4	Aspect Size, Backing Board, Column and Arrangement	25
4.5	Traffic Signal Lights	25
4.6	Flashing Operation of Traffic Signals	26
4.6.1	Flashing Red	26
4.6.2	Flashing Amber	26
4.6.3	Flashing Green	26
4.6.4	Mode of Operation	27
4.7	Signal Mounting Alternatives	27
4.7.1	Column Mounted Signals	27
4.7.2	Mast-Arm Mounted Signals	28
4.7.3	Span-Wire (Catenary) Mounted Signals	29
<b>5.0</b>	<b>TRAFFIC SIGNAL CONTROLLERS AND DETECTORS</b>	<b>37</b>
5.1	General	37
5.2	Fixed Time Controllers	37
5.2.1	Timing Characteristics	38
5.3	Vehicle Actuated Controllers	39
5.3.1	Semi-Actuated Controllers	39
5.3.2	Full-Actuated Controllers	40
5.3.3	Volume-Density Controllers	40
5.4	Controller Location	41
5.5	Detectors	42
5.5.1	Types and Functions of Vehicle Detectors	42
5.5.2	Application of Vehicle Detectors	43
5.5.3	Detection of Small Vehicles	44
5.6	Location of Detectors	44
5.7	Installation Considerations	45
5.7.1	Loop Detectors	45
5.7.2	Camera Detectors	46
5.7.3	Wireless radar and Infrared	46
5.7.4	Laser based Detectors	46
5.8	Considerations	46
<b>6.0</b>	<b>TRAFFIC SIGNAL TIMING</b>	<b>48</b>
6.1	Objective	48
6.2	Design Principles	48
6.2.1	Determination of Flow Rate, $v_p$	48
6.2.2	Determination of Saturation Flow Rate, S	48
6.2.3	Signalised Intersection Flow Characteristics	52
6.2.4	Capacity Analysis and Determination of Level of Service (LOS)	52

## CONTENTS

	<b>Page</b>
6.2.5 Determination of Lost Time, $t_L$ (s)	52
6.2.6 Determination of Effective Green time, $g$ (s)	52
6.2.7 Determination of Green Ratio, $g/C$	52
6.2.8 Determination of Lane Capacity, $c$ (veh/hr)	53
6.2.9 Determination of Degree of Saturation, $X$ ( $v_p/c$ ratio)	53
6.2.10 Determination of Flow Ratio, $y$	53
6.2.11 Determination of Optimum Cycle Time, $C_o$	54
6.2.12 Determination of Signal Settings	54
6.2.13 Determination of Pedestrian Crossing Time	55
6.2.14 Determination of Level of Service (LoS)	56
6.2.15 Determination of Delay, $d$	57
6.2.16 Guiding Principles	63
<b>7.0 DESIGN OF COORDINATED SIGNAL TIMING</b>	<b>65</b>
7.1 Introduction	65
7.2 Advantages	65
7.3 Applications	67
7.3.1 One-Way Road	67
7.3.2 Two-Way Road	67
7.4 Coordinated Signal System Design	69
7.4.1 Selection of A Cycle Length	69
7.4.2 Design Methodology for Arterial Routes	70
<b>REFERENCE</b>	
<b>GLOSSARY</b>	
<b>APPENDIX A: WORKSHEET</b>	A1 – A4
<b>APPENDIX B: STEP CALCULATION OF EXAMPLE</b>	B1 – B5
<b>APPENDIX C: EXAMPLE</b>	C1 – C4

## **CHAPTER 1: INTRODUCTION**

### **1.1 Objectives of Traffic Signal Control**

The overall objective of signal control is to provide for a safe and efficient traffic flow through intersections, along routes and in road networks. At individual intersections, the primary purpose is to assign right-of-way for alternate roads or road approaches in order to maximize capacity, minimize delay and reduce conflicts.

On a road system or network the overriding objective is to optimize the safety and efficiency of traffic flow on the system, which sometimes results in compromises at individual intersections.

### **1.2 Advantages and Disadvantages of Signal Control**

Traffic control signals are valuable devices for the control of vehicular and pedestrian traffic when properly used. They assign the right-of-way to the various traffic movements and thereby profoundly influence traffic flow. Traffic control signals that are properly designed, located, operated, and maintained will have one or more of the following advantages: -

- (a) They provide for the orderly movement of traffic.
- (b) They increase the traffic-handling capacity of the intersection if:
  - (i) Proper physical layouts and control measures are used, and
  - (ii) The signal operational parameters are reviewed and updated (if needed) on a regular basis (as engineering judgment determines that significant traffic flow and/or land use changes have occurred) to maximize the ability of the traffic control signal to satisfy current traffic demands.
- (c) They reduce the frequency and severity of certain types of crashes.
- (d) They are coordinated to provide for continuous or nearly continuous movement of traffic at a definite speed along a given route under favorable conditions.
- (e) They are used to interrupt heavy traffic at intervals to permit other traffic, vehicular or pedestrian, to cross.
- (f) They help to promote driver confidence by assigning right-of-way.

Traffic control signals are often considered a panacea for all traffic problems at intersections. This belief has led to traffic control signals being installed at many locations where they are not needed, adversely affecting the safety and efficiency of vehicular, bicycle, and pedestrian traffic. Traffic control signals, even when justified by traffic and roadway conditions, can be ill-designed, ineffectively placed, improperly operated, or poorly maintained.

Improper or unjustified traffic control signals can result in one or more of the following disadvantages: -

- (a) Excessive delay, especially during off peak periods.
- (b) Excessive disobedience of the signal indications,
- (c) Increased use of less adequate routes as road users attempt to avoid
- (d) the traffic control signals, and
- (e) Significant increases in the frequency of collisions (especially rear-end collisions).

JKR INTERNAL USED ONLY



## CHAPTER 2: SIGNAL INSTALLATION CRITERIA

### 2.1 General

A request to install new traffic signals (or upgrading an existing signalized intersection) may originate from various sources. The most usual sources include:-

- (a) Responsible agencies (e.g. JKR, City Hall, Municipalities etc).
- (b) Traffic Enforcement Agencies (e.g. Police)
- (c) Industrial or commercial developers and operators
- (d) Media / General Public

From whatever source the request may originate, the responsible agency must determine whether such requests are justified. It is for this purpose that the following criteria of selection were developed. These criteria should be viewed as guidelines, not as hard and fast values. Satisfaction of criteria does not guarantee that the signal is really needed. Conversely, the fact that a criteria is not fully satisfied does not constitute absolute assurance that signalization would not serve a useful purpose.

Awareness of local conditions and sound engineering judgement would make the guidelines more effective. In general, the following steps should be taken prior to the installation of traffic signal control: -

- (a) Determine the function of the intersection as it relates to the overall road system. A system of major roads should be designated to channel major flow from one section of the city to another. Intersection controls must be related to the major road system.
- (b) A comprehensive study of traffic data and physical characteristics of the location is necessary to determine the need for signal control and for the proper design and operation of the control.
- (c) Determine if the geometric or physical improvements or regulations will provide a better solution to the problem of safety or efficiency than the installation of signal control.
- (d) Use established warrants to determine if intersection control is justified.

The selection and use of traffic control signals should be based on an engineering study of roadway, traffic, and other conditions.

Engineering judgment should be applied in the review of operating traffic control signals to determine whether the type of installation and the timing program meet the current requirements of all forms of traffic.

If changes in traffic patterns eliminate the need for a traffic control signal, consideration should be given to remove it and replacing it with appropriate alternative traffic control devices, if any are needed.

If the engineering study indicates that the traffic control signal is no longer justified, and a proposal is made to remove the signal, removal should be accomplished using the following steps: -

- (a) Determine the appropriate traffic control to be used after removal of the signal.
- (b) Remove any sight-distance restrictions as necessary.
- (c) Inform the public of the removal study.
- (d) Flash the signal heads for a minimum of 30 days or shutdown, and install the appropriate stop control or other traffic control devices.
- (e) Remove the signal if the engineering data collected during the removal study period confirms that the signal is no longer needed.

## **2.2 Warrant Analysis**

Generally, the following warrants should be considered before installing any signal control. They are namely: -

- (a) Warrant No. 1: 8-Hour Volume
- (b) Warrant No. 2: Peak Hour / 1-Hour Volume
- (c) Warrant No. 3: Coordinated Signal System
- (d) Warrant No. 4: Pedestrian Safety
- (e) Warrant No. 5: Accident Experience

Traffic control signals should generally not be installed unless one or more of the warrants in this guideline is met.

### **2.2.1 Warrant No. 1: 8-Hour Volume**

Vehicular volume affects the efficiency and the Level of Service of an intersection. High traffic volume on the major road, especially during peak hours, would invariably cause considerable delay for the traffic on the minor road. For the purpose of determining the need for signal control, both the traffic volumes on the major and minor roads should be considered. A signal control is warranted if the traffic volume for each of any 8 hour of an average day meets the minimum requirements in **TABLE 2.1**. For the major road, the total volume of both approaches is used. For the minor road, the higher volume approach (one direction only) is used. An "average" day is defined as a weekday representing volumes normally and repeatedly found at the location.

**TABLE 2.1: VEHICULAR VOLUME REQUIREMENTS FOR WARRANT NO. 1**

Number of Lanes Each Approach		Minimum Requirements (vph)			
		Major Road *		Minor Road **	
Major Road	Minor Road	Urban	Rural	Urban	Rural
1	1	500	350	150	105
2 or more	1	600	420	150	105
2 or more	2 or more	600	420	200	140
1	2 or more	500	350	200	140

Notes:

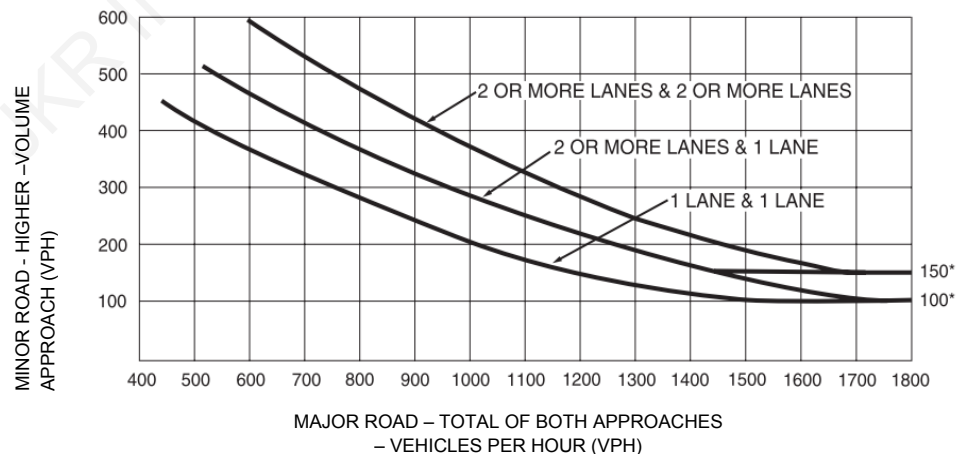
\* Total volume of both approaches

\*\* Higher volume approach only

**2.2.2 Warrant No. 2: Peak Hour / 1-Hour Volume**

Peak hour volumes could also be used to determine the need for signalization. This is applied in cases where, for one peak hour of an average day, traffic conditions are such that the minor road traffic experiences undue delay or hazard in entering or crossing the major road. This criteria warrants signalization when the peak hour major road volume (total vehicles per hour for both approaches) and the higher volume minor road approach (vehicles per hour for are direction only) fall above the curve for a given combination of approach lanes shown in **FIGURE 2.1**.

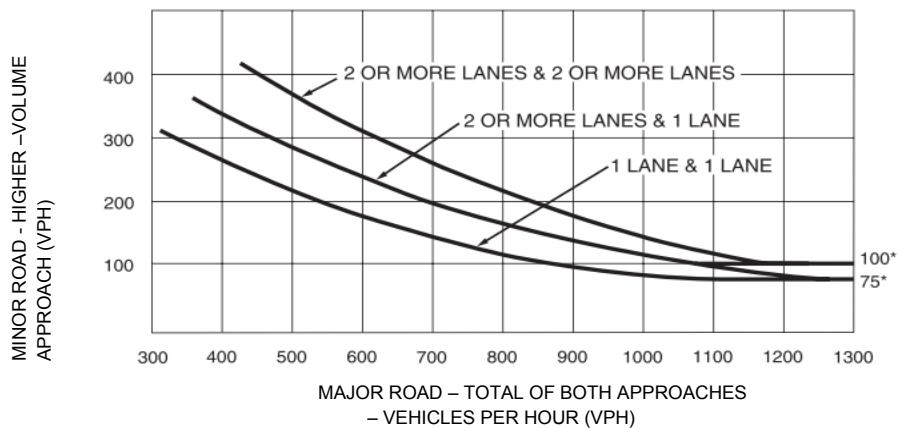
The requirements are lower when the 85 percentile speed of major road traffic exceeds 60 km/hr, or when the intersection lies within a rural area. The peak hour volume warrant is satisfied when the volumes referred to fall above the curve for the given combination of approach lanes shown in **FIGURE 2.2**.



\* Note: 150 vph applies as the lower threshold volume for a minor road approach with two or more lanes and 100 vph applies as the lower threshold volume for a minor road approach with one lane

**FIGURE 2.1: PEAK HOUR VOLUME WARRANT – URBAN OR LOW SPEED**

Source: Figure 4C-3, Manual on Uniform Traffic Control Devices (MUTCD), 2009



\* Note: 100 vph applies as the lower threshold volume for a minor road approach with two or more lanes and 75 vph applies as the lower threshold volume for a minor road approach with one lane

**FIGURE 2.2: PEAK HOUR VOLUME WARRANT – RURAL OR HIGH SPEED**  
 Source: Figure 4C-4, Manual on Uniform Traffic Control Devices (MUTCD), 2009

### 2.2.3 Warrant No. 3 - Coordinated Signal System

In some locations, it may be desirable to install a signal to maintain a proper grouping or platooning of vehicles and regulate group speed even though the intersection does not satisfy other warrants for signalization. Several advantages may accrue from this type of consideration. Moving the traffic in platoons at the desirable speed would reduce the number of stops and delays. Accident reduction may also be expected with reduction of stops and speeds.

On a one-way road (or a road with predominantly unidirectional traffic), this warrant applies when the adjacent signals are so far apart that they do not provide the necessary vehicle platooning and speed control. On a two-way road, the warrant is satisfied when the adjacent signals do not provide the necessary degree of platooning and the proposed and adjacent traffic control signals will collectively provide a progressive operation.

A traffic control signal installed under this warrant should be based on the 85-percentile speed unless a traffic engineering study indicates that another speed is more appropriate. As a guide, this warrant should not be applied where the resultant spacing of traffic control signals would be less than 300m.

#### **2.2.4 Warrant No. 4 - Pedestrian Safety**

Signalization of an intersection also promotes pedestrian safety. It is warranted for signalization when, for each of any 8 hours of an average day, the following traffic volume exists: -

- (a) On the major road, 600 or more vehicles per hour enter the intersection (total of both approaches): or where there is a raised median island 1.2 m or more in width, 1000 or more vehicles per hour (total of both approaches) enter the intersection on the major road.

**AND**

- (b) During the same 8 hours as in paragraph (a) there are 150 or more pedestrians per hour on the highest volume crosswalk crossing the major road.

When the 85-percentile speed of major road traffic exceeds 60km/hr in either an urban or a rural area, or when the intersection lies within the built-up area of an isolated community having a population of less than 10000, the minimum pedestrian volume is 70 percent of the requirements above.

A signal installed under this warrant at an intersection should be of the vehicle actuated type with pedestrian detection capabilities. If such a signal is installed at an intersection within a traffic signal system, it should be equipped and operated with control devices which provide proper coordination.

A traffic control signal may not be needed at the location if adjacent coordinated traffic control signal consistently provides gaps of adequate length for pedestrian to cross the road.

Special considerations should be given at schools where large number of children crosses a major road on the way to and from school. The requirement for school children to cross is based on the number of adequate gaps available in the vehicular traffic on the major road available. A signal may be installed to artificially create these gaps if other methods for improvements are not adequate.

Before a decision is made to install a traffic control signal, consideration should be given to the implementation of other remedial measures such as warning signs and flashers, school speed zones or grade-separated crossing.

This warrant shall not be applied at locations where the distance to the nearest traffic control signal or STOP sign is less than 100m, unless the proposed traffic control signal will not restrict the progressive movement of traffic.

### 2.2.5 Warrant No. 5 - Accident Experience

Accident prone areas with accident types which are correctable by signal control warrants signalization. This claim should be substantiated by accident records for a period of two to three years. The need for a traffic control signal shall be considered if an engineering study finds that one or more of the following criteria are met: -

- (a) An adequate trial of less restrictive remedies with satisfactory observance and enforcement has failed to reduce the accident frequency, **AND**
- (b) There exists a record of five or more reported accidents in a 12-month period. These accidents should be of types susceptible to correction by traffic signal control, **AND**
- (c) There exists a volume of vehicular and pedestrian traffic not less than 80% of the requirements specified in warrants 1 to 4.

Any traffic signal installed solely on this warrant should be semi traffic-actuated (with control devices which provide proper coordination if installed at an intersection within a coordinated system) and normally should be fully traffic-actuated if installed at an isolated intersection.

## CHAPTER 3: SIGNAL OPERATION REQUIREMENTS

After establishing that a signal is warranted at a particular location, the next major step involves determining the most appropriate method of control. Decisions to be made at this level include:

- Determining what are the phasing requirements
- Whether the signal should be fixed time or vehicle actuated.

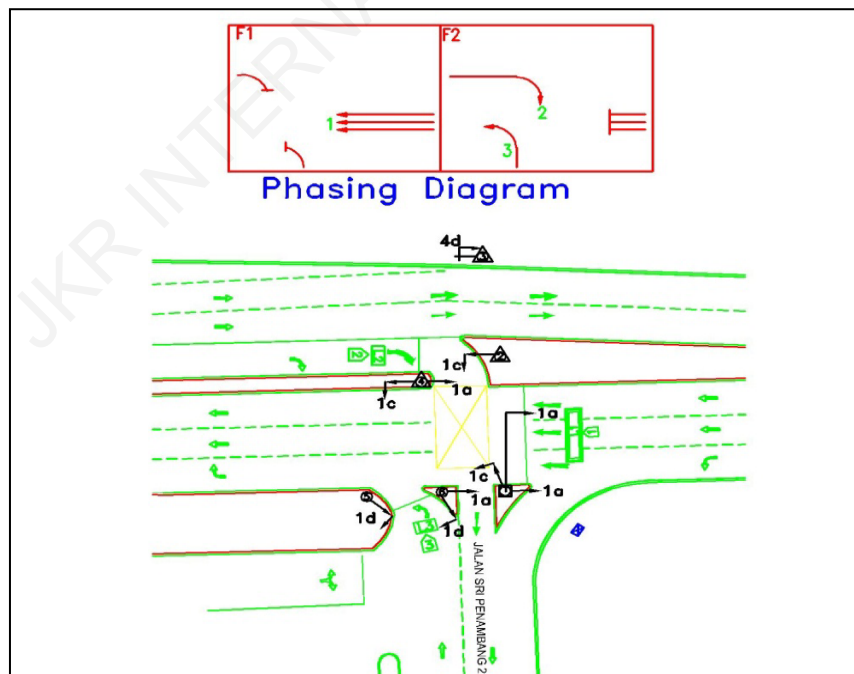
### 3.1 Phasing Elements

Definitions:-

- A signal phase is allocated to a traffic movement receiving the right of way simultaneously during one or more intervals.
  - A traffic movement is a single vehicular movement, a single pedestrian movement, or a combination of vehicular and pedestrian movement.
  - Cycle length is the sum of all traffic phase.
- There are a number of phasing options available.

#### 3.1.1 Two Phase (3-Legged Junction)

The simplest signal cycle is a two phase cycle, in which each road in turn receives a green indication while the cross-road receives a red indication. A phasing diagram for a two- phase cycle is shown in **FIGURE 3.1**.

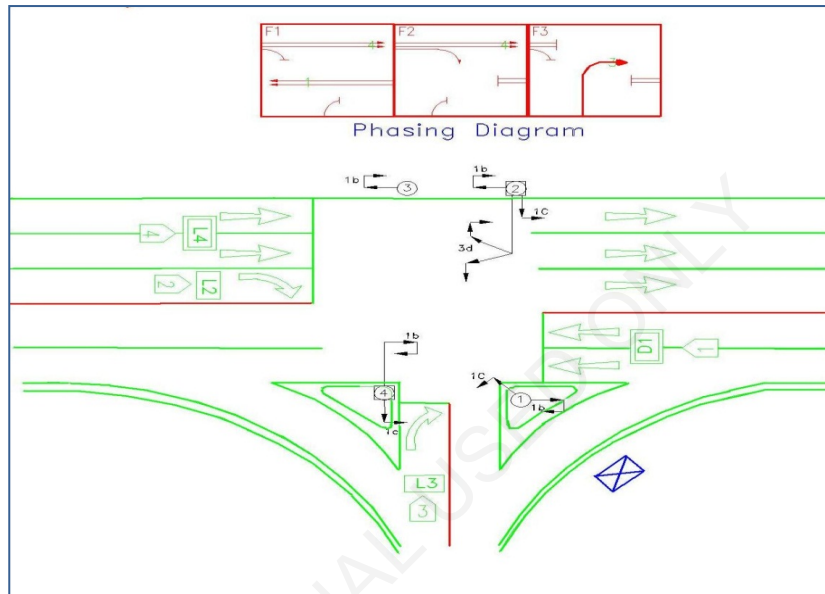


**FIGURE 3.1: 3- LEGGED JUNCTION (TWO – PHASE)**

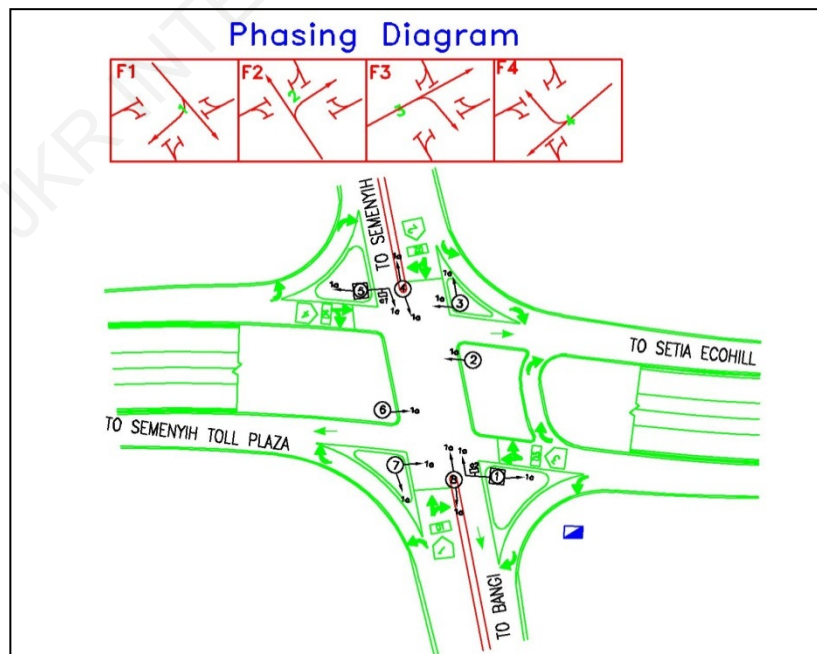
### 3.1.2 Multi Phase (3-Legged & 4-Legged Junction)

Three and four phase cycles are also quite common where there are heavy turning movements. The purpose of such multiphase cycle is to prevent traffic conflicts by giving heavy right t-turn movements separate signal indications.

**FIGURE 3.2, FIGURE 3.3** and **FIGURE 3.4** illustrate multiplan signal cycles (three, four and five-phase).

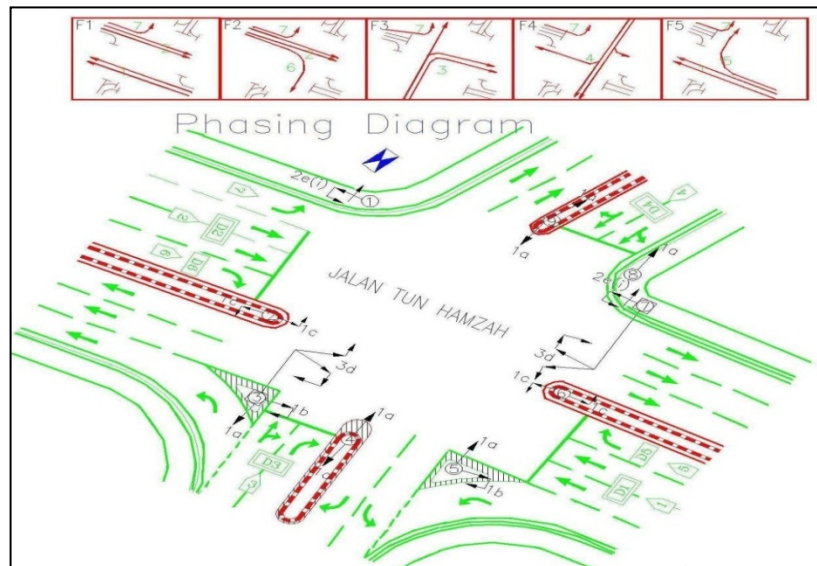


**FIGURE 3.2: 3-LEGGED JUNCTION (THREE – PHASE)**



**FIGURE 3.3: 4-LEGGED JUNCTION (FOUR – PHASE)**

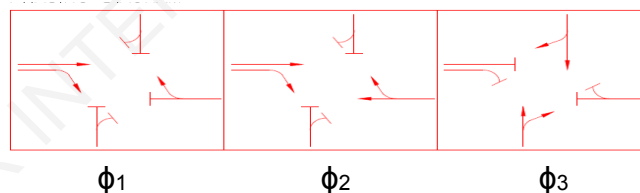




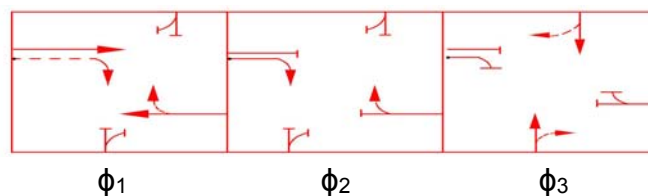
**FIGURE 3.4: 4-LEGGED JUNCTION (FIVE – PHASE)**

When right turning movements are heavy, protecting its movements is quite often essential to avoid unnecessary conflict. The basic sequences which accommodate right-turn movements include:

- (a) Heaviest right turn protected. This is a “lead right” in which the right-turning vehicles from only one approach are protected and move on an arrow indication preceding the opposite through movement; or a “lag right” when the protected right turn follows the through movement phase. See **FIGURE 3.5** and **FIGURE 3.6**.

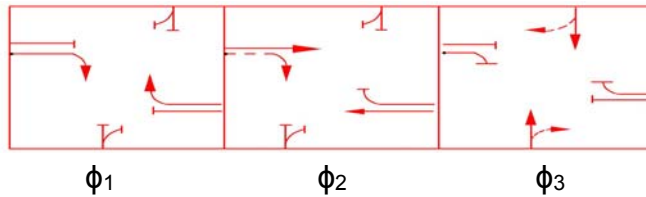


**FIGURE 3.5: HEAVIEST RIGHT TURN PROTECTED (LEAD RIGHT)**

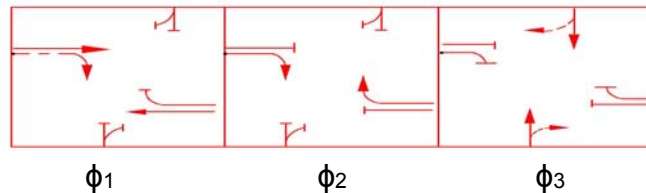


**FIGURE 3.6: HEAVIEST RIGHT TURN PROTECTED (LAG RIGHT)**

- (b) Both right turn protected-no overlap. When the opposing right turns move simultaneously followed by the through movements, it is termed “lead dual right”. If the right turn follow the through movement it is called a “lag dual right”. See **FIGURE 3.7** and **FIGURE 3.8**.

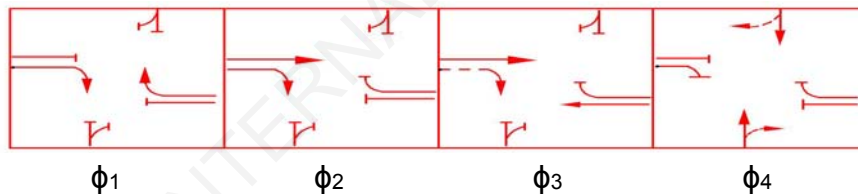


**FIGURE 3.7: BOTH RIGHT TURN PROTECTED-NO OVERLAP (LEAD DUAL RIGHT)**



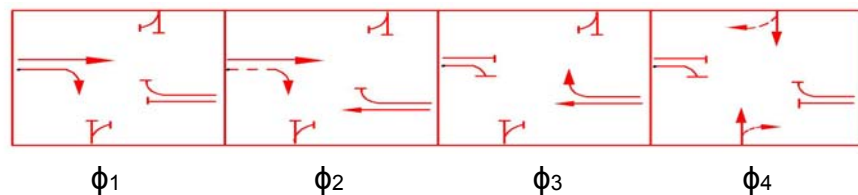
**FIGURE 3.8: BOTH RIGHT TURN PROTECTED-NO OVERLAP (LAG DUAL RIGHT)**

- (c) Both right turns protected – with overlap. In this operation, opposing right turns start simultaneously. When one terminates, the through movement in the same directions as the extending right is terminated, the remaining through movement is started. When this type phasing is used on both roads, it is called “quad right phasing”. See **FIGURE 3.9**.



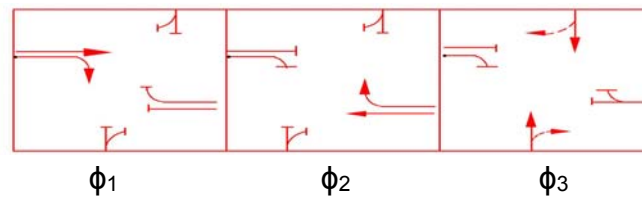
**FIGURE 3.9: BOTH RIGHT TURNS PROTECTED – WITH OVERLAP (QUAD RIGHT PHASING)**

- (d) Lead lag – This Phasing is combined with a leading protected right in one direction, followed by the through movements, followed by a lag right in the opposing direction. It is sometimes used in systems to provide a wider two-way through band. See **Figure 3.10**.



**FIGURE 3.10: LEAD LAG**

- (e) Directional separation – First one approach moves with all opposing traffic stopped, and then the other approach moves with the first approach stopped. See **FIGURE 3.11**.



**FIGURE 3.11: DIRECTIONAL SEPARATION**

(The Right signal displays shown in **FIGURE 3.5** to **3.11** are those visible to the starred (\*) right turn movement)

Although there are no limitations on the numbers of phases that can be utilized, as a general rule they should be held to a minimum, especially in pre-timed controllers. More phases tend to increase the cycle length and delay as they reduce the green time available to the other phases and intersection efficiency is impaired by starting delays, additional change intervals, longer cycles, and so forth. Multiphase actuated controllers when properly operated and timed tend to reduce these undesirable effects.

In determining the number of phases required at an intersection, the goals of safety and capacity may conflict. For example, in many situations protected right-turn phases are safe for right-turning vehicles than permissive right turns. However, the added phases may result in longer cycle lengths, reduced progression in systems, and increased delay and percent of vehicles stopped. These factors adversely affect traffic performance, capacity and fuel consumption, and may tend to reduce safety for all traffic.

In congestion prone areas, it is recommended to conduct feasibility studies for implementing permissive left turns. Permissive left turns can be implemented provided the average speed of vehicles from opposing directions does not impose hazardous conditions for vehicles attempting the permissive turns.

Left Turn On Red (LTOR) Scheme permits motorists to turn left during a red traffic signal indication after stopping and giving way to conflicting vehicles and crossing pedestrians. Left turn on red can be considered to be implemented at suitable and appropriate junctions.

The LTOR scheme reduces delays (time savings) for left turning vehicles and clears the left-turning traffic queue faster which in turn results in added benefits such as reduced pollution at intersections and less energy consumption (energy conservation); and small increases in intersection capacity and level of service, in some cases.

Generally the LTOR scheme can be implemented at junctions with the following characteristics:

- Sight distance/speed environment: Adequate sight distances that allow road users to have a good, clear view of the surrounding traffic situation; without on-street parking and traffic operating at moderate to low vehicle speeds.
- Geometrics/lane arrangement: LTOR movements from a single lane with adequate (non-acute) turning radius and wide receiving (entry) lanes; no U-turn for the main road traffic and no right turns from opposing approach if at cross-intersections. Normally LTOR scheme is installed principally at side roads of T-intersections.
- Pedestrian/vehicular activities: A generally low number of crossing pedestrians and away from routes often used by young and disabled persons such as in the vicinity of primary schools and hospitals.

It is more suitable at intersections with fairly heavy traffic demand in the LTOR lane.

Junctions where LTOR is permitted require additional road signs to notify motorist on the side road of Left Turn on Red and to Stop and Give Way to pedestrians and main road traffic. As for the pedestrians, road sign reminding to beware of turning vehicles shall be in place.

### **3.2 Right-Turn Phasing**

In general the phasing issue is primarily a right-turn issue. When right – turning volumes and opposing through volumes increases, a point is reached where right-turning traffic cannot find safe and adequate gaps. This will minimize the problem somewhat by providing storage space for those waiting for an acceptable gap (normally not less than 4 seconds, subject to traffic and site condition) in opposing traffic to turn. The decision to provide separate right-turn phasing should be carefully weighed.

Two common right-turn phasing alternatives are the lead right and the lag right.

- (i) Lead right: the protected right turn precedes the accompanying through movement.
- (ii) Lag right: the right turn phasing follows the through movement.

The most common practice is to allow opposing right turns to move simultaneously. This operation generally requires separate right – turns to move simultaneously. This operation generally requires separate right-turn storage lanes. The lead right and lag right phasing sequences can be implemented comfortably in the 5 phase system of 4 way junctions. These 5 phase systems are usually applicable for large 4 way junctions with a major arterial flow present

which constitutes the dominant major flow. The minor right turn flows constitute volume patterns throughout the day.

In actuated control, split the right-turn phase so that when the demand on one right-turn phase ceases, the opposing through movement is released. This works very well with lead-right operations. In lag right, it is usually desirable for the right turns to operate simultaneously. Both sequences have advantages and disadvantages as summarized in **TABLE 3.1** and **TABLE 3.2**.

### 3.3 Suggested Guidelines for Separate Right – Turn Phases

The following suggested guidelines maybe applied when considering the addition of separate right-turn phasing for intersections having an exclusive right-turn lane.

- (a) Volume
  - (i) The volumes of right – turning vehicles and conflicting through vehicles during the peak hour is greater than 100,000 on a four-lane road or 50,000 on a two-lane road.
  - (ii) Right-turn volumes greater than 100 vehicles during the peak hour.
  - (iii) Right-turn peak period volumes greater than two vehicles per cycle per approach still waiting at the end of green.
- (b) Delay
  - (i) Minimum right-turn volumes greater than two per cycle during the peak period and the average delay per right turning vehicle greater than 35 seconds.
- (c) Accident experience
  - (i) Four right-turn accidents in one year or six in two years for one approach.
  - (ii) Six right – turn accidents in one year or ten in two years for both approaches.
- (d) Geometrics
  - (i) Two or more exclusive right-turn lanes are necessary.

**TABLE 3.1: LEAD RIGHT-TURN PHASE**

Advantages	Disadvantages
Increases intersection capacity on one or two-lane approaches without right-turn lanes when compared with two-phase traffic signal operation.	Right turns may pre-empt the right of way from the opposing through movement when the green is exhibited to the stopped opposing movement.
Minimizes conflicts between right-turn and opposing straight through vehicles by clearing the right – turn vehicles through the intersection first.	Opposing movements may make a false start in an attempt to move with the leading green vehicle movement.
Drivers tend to react quicker than with lag-right operations.	

**TABLE 3.2: LAG – RIGHT TURN PHASE**

Advantages	Disadvantages
Both directions of straight through traffic start at the same time.	Right-turning vehicles can be trapped during the right–turn yellow change interval as the through traffic is not stopping as expected.
Approximates the normal driving behavior of vehicle operators.	
Provides for vehicle/pedestrians have cleared the intersection by the beginning of the lag green.	Creates conflicts for opposing right turns at start of lag interval as opposing right – turn drivers expected both movements to stop at the same time.
Where pedestrian signals are used, pedestrians have cleared the intersection by the beginning of the lag green interval.	Where there is no right turn lane, an obstruction to the through movement during the initial green interval is created.
Cuts off only the platoon stragglers from adjacent interconnected intersection.	The hazards in lag-right operations are such that they tend to pre-timed operations or to any specific situations in actuated or control such as “T” intersections.
	A green arrow cannot be displayed during the circular yellow, therefore, a stop – start situation is necessary with simultaneously opposing right turns.

### 3.4 Selection of Fixed Time Or Actuation Signal

#### 3.4.1 Fixed Time Signal

This type of signal directs traffic to stop and permits it to proceed in accordance with a single, predetermined time schedule or a series of such schedules. The traffic signal is set to repeat a given sequence of signal indications regularly.

##### 3.4.1.1 Advantages of Fixed Time Signals:

- (a) Simplicity of equipment provides relatively easy servicing and maintenance.
- (b) Can be coordinated to provide continuous flow of traffic at a given speed along a particular route, hence providing positive speed control.
- (c) Timing is easily adjusted in the field.
- (d) Under certain conditions can be programmed to handle peak conditions.

#### 3.4.1.2 Disadvantages of Fixed Time Signals:

- (a) Do not recognize or accommodate short-term fluctuations in traffic demand.
- (b) Can cause excessive delay to vehicles and pedestrians during off-peak periods

### 3.4.2 Vehicle Actuated Signals

The operation of this type of signal is varied in accordance with the demands of traffic as registered by the actuation of vehicle or pedestrian detectors as one or more approaches.

#### 3.4.2.1 Advantages of Vehicle Actuated Signals:

- (a) Usually reduce delay (if properly programmed) fluctuations.
- (b) Usually increase capacity by auto-adjusting green time.
- (c) Especially effective at multiple phase intersections.

#### 3.4.2.2 Disadvantages of Vehicle Actuated Signals:

- (a) The cost of actuated installations is more expensive than pre-time signal installation.
- (b) Actuated controllers and detector are much more complicated than pre-timed controller, and therefore increasing the cost of maintenance due to requirement of skilled inspectors.
- (c) Detectors are costly to install and require careful inspection and maintenance to ensure proper operation.

### 3.4.3 Traffic-adjusted System

These are centrally controlled from a control center via centralized monitoring system and have settings can be reprogrammed based on data input from the detectors.

### 3.4.4 Comparison of Fixed Time and Vehicle Actuated Control

With basic fixed time control, a consistent and regularly repeated sequence of signal indication is given to traffic. By use of attached auxiliary devices, or centralized monitoring system, the operation of fixed time control can be changed within certain limits to meet the requirements of traffic more precisely.

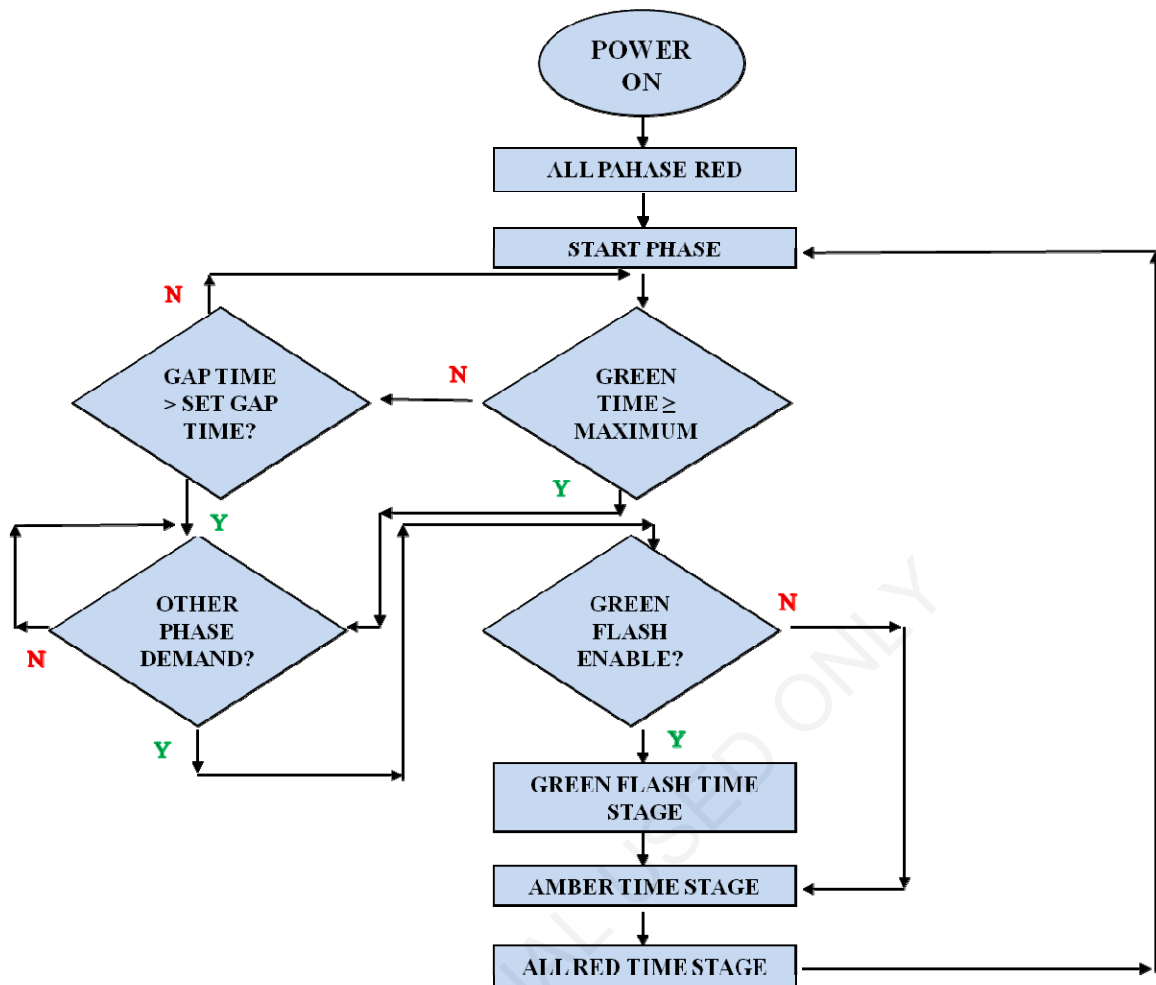
Fixed time control is best suited to intersections where traffic patterns are relatively stable or where the variations in traffic flow that do occur can be accommodated by a fixed time schedule without causing unreasonable delay or congestion. Fixed time control is particularly adaptable to intersections where it is desired to coordinate operation of signals with existing or planned signal installations at nearby intersections on the same road or adjacent roads.

Vehicle-actuated control differs basically from fixed time control in that signal indication are not of fixed length, but are determined by and confirmed within certain limits to the changing vehicle volume as registered by various forms of vehicle and pedestrian detectors. The length of cycle and the sequence of intervals may vary from cycle to cycle, depending on the type of controller. In some cases, certain intervals may be omitted when there is no actuation or demand from waiting vehicles or pedestrians.

**TABLE 3.3: VEHICLE ACTUATED VERSUS FIXED TIME**

<b>Vehicle Actuated</b>	<b>Fixed Time</b>
Cycle length is based on volume of vehicle	Fixed cycle length
Phase length is based on volume of vehicle	Fixed phase length
Number and sequence of phase can be change based on volume of vehicle	Fixed number and sequence of phase
Control of isolated intersections attempt to adjust green time continuously	No recognition is given to the current traffic demand on the intersection approaches





**FIGURE 3.4: CONCEPT OF VEHICLE ACTUATED FLOWCHART**

### 3.5 Digital Countdown

Digital Countdown is 2 or 3 digit numeric displays mounted adjacent to a signal aspect. These countdowns provide the time in seconds for the red or green phases.

Countdown timers at red lights would inform drivers how much time remained before the light turns green, while timers at green lights would tell drivers how much time was left before the light turns red.

#### Type of Countdown

##### 3.5.1 Fixed/Multiplan Countdown

Fixed/Multiplan countdown can display a fix red and green time of the phases. This countdown is not very efficient as compared to the VA

countdown and VA jump countdown because if there is less traffic or no traffic, it will still start from a fixed preset timing value.

### **3.5.2 VA (Vehicle Actuated) Countdown**

VA countdown can display the timing according to the change in VA traffic data. This countdown would display time which changes every cycle according to the volume of vehicles on each phase. During the running of current cycle it will observe the traffic volume to set the green timing for the next phase at each phase or direction.

### **3.5.3 VA (Vehicle Actuated) Jump Countdown**

VA jump countdown display full green timing and red phase timing according to the vehicle volumes with skip phase and jump down features. If volume of traffic decreases during the running then it will automatically jump down to an optimum value to save the time for other phases and if there is no vehicle in a phase it will skip that phase so that other phase do not have to wait.

### **3.5.4 Countdown in Amber Aspect**

Countdown in amber aspect displays the timing within the 300mm amber aspect itself. It displays timing in red colour when the red light turns on, and green colour when the green light turns on. During transitions between green light and red light, amber light (in circular shape) will be displayed. Algorithm for countdown in amber aspect is vehicle-actuated (VA) and the communication to the controller is via wireless RF signals.

## CHAPTER 4: SIGNAL HEAD AND LOCATION

To serve its intended purpose in directing and regulating traffic flow, two fundamental principles must be carefully considered, i.e. conspicuity and clarity. **Conspicuity** means that signal must not only be visible, but must be obvious to the eye and attract attention. **Clarity** means that the message or direction given can be easily understood. In other words, the signal must be seen in order for the motorist to react and the required action must be obvious.

### 4.1 Signal Head Requirements

For the motorist to respond effectively to the traffic signal, these basic requirements have to be considered:-

- (a) The amount of light reaching the eye.
- (b) The position of the signal in the field of view.
- (c) The ratio of the signal-to-background contrast.
- (d) The amount of competing information sources (visual clutter)
- (e) The degree to which the appearance of the signal is expected.
- (f) The degree to which the precise location of the signal is known.
- (g) The degree to which the message conforms to the motorist's knowledge and expectations

The physical details of these elements that affect the motorist's ability to see and respond to the message transmitted are provided below.

#### 4.1.1 Minimum Visibility Requirements

**Minimum visibility** for a traffic signal is defined as the **distance** from the stop line at which a signal should be continuously visible for various approach speeds.

**TABLE 4.1** shows, for example, that if the 85<sup>th</sup> percentile approach speed is 56km/h the signal head should be visible from a distance of 99m. And they should be continuously visible from that point all the way to the stop line at the intersection.

**TABLE 4.1: MINIMUM VISIBILITY DISTANCES**

85 <sup>th</sup> percentile speed, km/h	Minimum Visibility Distance, m	Desirable Visibility Distance, m
32	53	81
40	66	99
48	82	123
56	99	146
64	119	174
72	140	201
80	165	232
88	190	265
97	218	299

As these distances do not consider the impact of grade, it may be necessary to adjust the minimum visibility distances to reflect an upgrade or downgrade approach. **TABLE 4.2** can be used for this purpose.

**TABLE 4.2: ADJUSTMENTS FOR GRADE GUIDELINES**

85 <sup>th</sup> percentile speed, km/h	Add for Downgrade, m		Subtract for Upgrade, m	
	5 %	10 %	5 %	10 %
32	2	5	2	3
40	3	6	3	5
48	5	9	3	6
56	6	14	5	8
64	9	20	6	11
72	12	27	9	15
80	15	37	11	20
88	18	46	14	24
97	21	58	17	29

If the signal head is not visible from the distance specified by the chart, signs WD. 22 and WD. 17 must be installed to warn motorists.

#### **4.2 Number and Location of Signal Head**

It is advisable that there be at least two sets of signal head (primary and secondary) for each through approach to an intersection or other signalized location. A single aspect is permitted for control of an exclusive lane provided that this single aspect is in addition to the minimum two from any movement lanes.

Supplemental signal head (tertiary, dual primary and dual secondary) are recommended if their use will improve what would otherwise be marginal visibility or detectability of the signal indication. Additional signal head used for this purpose should be located as close as possible to the motorist's projected line of sight.

Typical situations where supplemental signal head may materially improve visibility include: -

- (a) Approach widths in excess of three full lanes and very wide intersecting road
- (b) Motorist uncertainty concerning the proper location at which to stop
- (c) High percentages of large trucks in the traffic stream that tend to block the view of signal lights in their normal location.
- (d) Approach alignment that makes continuous visibility of normally positioned signals impossible.

The placement of the signal head depends on the visibility requirements for a specific location. Generally, the precise location should consider the lateral and vertical angles of sight toward the signal as determined by: -

- (a) typical motorist eye position
- (b) vehicle design
- (c) the vertical, longitudinal, and lateral position of the signal head

The first two factors are relatively consistent. It is the third factor that varies as a function of the intersection geometry. Accordingly, the optimum physical layout of the individual intersection must be carefully designed to assure that the signal indication lies within the motorist's cone of vision.

#### 4.2.1 Cone of Vision

Vertically, a motorist's vision is limited by the top of the vehicle's windscreen. This restriction requires that the signal be located far enough beyond the stop line to be seen by the motorist of a stopped vehicle. The lateral location of the aspect is based on the motorist's cone of vision and the width of the intersecting cross roads.

Generally a motorist's lateral vision is excellent up to  $5^\circ$  on either side of the center line of the eye position (a cone of  $10^\circ$ ). Vision is still very good up to  $10^\circ$  on either side (cone of  $20^\circ$ ). At  $20^\circ$  on either side (cone of  $40^\circ$ ), the motorist's vision is considered as "adequate". Therefore it requires at least one (and preferably two) signal heads be located within a cone of  $40^\circ$ , which is  $20^\circ$  to the left or  $20^\circ$  to the right of the "center of the approach lanes".

This constitutes the **maximum acceptable cone**.

The cone of vision originates at a center point of the approach lanes at the stop line. Parking lane is usually excluded and separate turn lanes (slip roads) are included unless they are controlled by separate signal head.

This concept is illustrated in **FIGURE 4.1**. The maximum cone of vision is shown on a typical two-lane approach.

#### 4.2.2 Height of Signal Head

- (a) Column Mounted Signal Head Intended For Motorist

For both vertical column and joint used column, the center of the green aspect shall be of minimum 2.5m and maximum 3.5m above the carriageway level.

**FIGURE 4.2** shows the height of column mounted signal head.

- (b) Mast Arm Mounted Signal Head Intended For Motorist

For both mast arm column and joint used mast arm column, the bottom of the housing of an overhead signal aspect shall be of minimum 5.5m and maximum 6.5m above the carriageway level.

**FIGURE 4.3** shows the height of mast-arm mounted signal head.

(c) Column Mounted Signal Head Intended For Pedestrian

The center of the green aspect shall be 2.5m above the carriageway level. A typical signal indication for pedestrian signal head shows a red man standing to indicate STOP and an animated green man walking to indicate GO. The signal head also equipped with fixed digital countdown and an audible signal (buzzer) to cater for disabled pedestrian.

**FIGURE 4.4** shows the dimensions and signal indication of pedestrian signal head.

### 4.2.3 Designation and Function

The designation and function of signal head is as follows:

- (a) Primary signal head (mandatory) – located at the left side of the roadways adjacent to the stop line on or other point where traffic is required to stop. Their principal function is to warn approaching traffic of the state of the signals, and to stop traffic at the correct position. In the absence of a stop line, traffic is legally required to stop before passing the primary signal.
- (b) Secondary signal head (mandatory) – located to the right side of the roadways, beyond the point where traffic is required to stop (within a maximum of 35m beyond the stop line), in a position readily visible to traffic at the stop line. Their principal function is to indicate the stopped traffic the start of a running phase and to control through traffic.
- (c) Dual primary signal head (additional) - Where the secondary signal head is more than 35m and less than 45m beyond the stop line, there shall be dual primary signal aspects, located to the right side of the roadways adjacent to the stop line or other point where traffic is required to stop. Their principal function is to back up the primary signals.
- (d) Dual secondary signal head (additional) - located to the far right side of the roadways where the secondary signal head is installed at the median or median island. Their principal function is to back up the secondary signals.
- (e) Tertiary signal head (additional) – located to the left side of the roadways beyond the point where traffic is required to stop. Their principal function is to back up the secondary signals the start of a running phase. To give clear visibility to the motorist, tertiary signal head often installed as overhead mounted.

**FIGURE 4.5** illustrates the designation of signal head for different types of junction.

#### 4.2.4 Other Location Criteria

- (a) Where a signal head is meant to control a specific lane or lanes of approach, its position should be in line with the path of the movement.
- (b) The overhead signal heads is installed on an intersection with a minimum of two approach lane where the roads are also used by heavy vehicles such as lorries and buses. The location of the overhead signal aspect should be on the secondary side.
- (c) Where median or separators are too narrow for signals to be placed on them, signal aspect should be located as though the median or separator were non-existent.
- (d) At an intermediate location on a pedestrian refuge, median or median island where either the crossing distance exceeds 25m, or the crossing is staged at the intermediate point and each stage is controlled as a separate movement, additional pedestrian signal should be placed on the median column.

#### 4.3 Number of Signal Aspects Per Signal Head

Each signal head, except in pedestrian signals, shall have at least three signal aspects, but not more than six. The signal aspects shall be Red, Amber or Green in color, and shall be a circular or arrow type of indication.

**FIGURE 4.6** shows the typical arrangement of signal aspects in signal head

#### 4.4 Aspect Size, Backing Board, Column and Arrangement

- (a) For uniformity, it is recommended that one standard size of signal aspect is used, which is the 300 mm lens. All these signal aspect should be mounted on a fiber-based backing board with an orange colored border.
- (b) The column should be colored in black and orange band with a 0.5m interval.
- (c) Visors should be used in all installations. All signal aspects shall be fitted with type A visor.

**FIGURE 4.7** shows the different types of visors for signal aspect

#### 4.5 Traffic Signal Lights

All components, their installation and performance, shall be in accordance with MS 2478 or BS EN12368 unless otherwise specified herein. The color of the light transmitted by the signals shall comply with the limits set out in MS 2478 standard.

## **4.6 Flashing Operation of Traffic Signals**

All traffic signal head installations shall be provided with an electrical flashing mechanism. An automatic means, or where appropriate, a manual switch shall be provided to operate this.

### **4.6.1 Flashing Red**

The twin alternate flashing red is meant to control vehicles, for emergency services facilities. It indicates that motorists must stop until signal is switched off e.g. at railway level crossing, at fire department or give way intersection.

### **4.6.2 Flashing Amber**

The signal indication in flashing amber shall be flashed continuously at a rate 30 to 40 times per minute. The illuminated period of each flash shall be between half and two thirds of the total flash cycle.

When traffic control signals change to flashing amber, the following meanings imply,

- (a) At an intersection, as a temporary measure because of traffic signal lights malfunction / breakdown.
- (b) Malfunctions include green conflict, lamp missing, fuse blown, MCCB tripped and lamp conflict among others.
- (c) It indicates that there is a need to exercise caution while proceeding.
- (d) On dedicated pedestrian crossing, it indicates that motorists may proceed but are to give way to pedestrians on the associated crosswalk.
- (e) Low-traffic period control (usually after midnight and before dawn)

### **4.6.3 Flashing Green**

Flashing green (normally during last 5 seconds of green time) can be used to indicate that signal is going to change from green to amber soon.

The advantages of the flashing green are:

- a) Motorists would be aware of the changing signal and would have ample time to stop
- b) As a precautionary safety measure

The disadvantages of the flashing green are:

- a) Motorists tend to speed when the green signal starts flashing
- b) In the case of actuated signalized junction, it reduces the junction capacity by adding the flashing time into the green time when the green time is to be cutoff for the next phase to commence



#### **4.6.4 Mode of Operation**

Automatic changes from flashing to stop-and-go operation shall be made, preferably at the beginning of the common major road green interval, (i.e. green conflict - when a green light is shown in both directions on the major road).

Where there is no common major road green interval, the automatic change from flashing to stop-and-go operation shall be made at the beginning of the green interval for the major traffic movement on the major road.

Automatic changes from stop-and-go to flashing operation shall be made at the end of the common major road red interval, (i.e., when a red indication is shown on both opposing directions on the major road).

It is necessary to provide a short, steady all red intervals (anti-de facto red) for the other approaches before changing from flashing amber to green on the major approach.

#### **4.7 Signal Mounting Alternatives**

There are three basic ways that signal head may be mounted:

- (a) Column mounted
- (b) Mast-arm mounted
- (c) Span-wire (catenary) mounted

All aspects shall be vertically mounted. The type of mounting used depends, to some extent, on local practice, aesthetic and cost.

All column used to mount traffic signal head shall be painted with alternate black and orange until the level of 3.5m to 4.0m using epoxy-coated paint.

##### **4.7.1 Column Mounted Signals**

The term column mounted signals usually refer to signal head mounted on tubular hollow hot-dipped galvanized (HDG) steel column. The diameter shall be of 100mm and fitted with a weatherproof cap to prevent ingress of water. Signals may also be mounted on column used for other purposes, e.g. road lighting column. The column shall be at a distance not less than 1m after the edge stop line, preferably 2m to 3m. In area where there is no kerb, the steel column should be erected so that the signal aspect is clear of the road shoulder (or usable area) and should be between 600mm to 1m from the edge of the nearest traffic lane.

4.7.1.1 Advantages are:

- (i) Low installation costs.
- (ii) Easy maintenance, no roadway interference.

- (iii) Generally considered as most aesthetically acceptable.
- (iv) Generally good locations for pedestrian signals and push buttons.
- (v) Where wide medians with right-turn lanes and phasing exist, provide good visibility.

#### 4.7.1.2 Disadvantages are:

- (i) Requires underground wiring and cable pits which may offset initial cost advantages.
- (ii) May not provide locations which meet minimum conspicuity.
- (iii) May not provide mounting locations that allows clear signal display.
- (iv) Height limitations may provide problems where approach is on a vertical curve (hilly).
- (v) Subject to collision by heavy vehicles or unfortunate accidents

### 4.7.2 Mast-Arm Mounted Signals

Mast-arm mounting is a cantilevered structure which permits the overhead installation of the signal head without overhead support cables and external signal wiring. The cable connecting the signal heads to the controller is run inside the column and arm structure. The mast-arm mounting can be effectively combined with column-mounted signals. The mast-arm mounted signal head are recommended to be used as secondary or tertiary signal, when not constrained by traffic and site conditions.

The length of mast-arm is typically at 5.5m from the center of column, but it can varies from 3.5m – 6.5m depending on the geometric of the junction designed.

#### 4.7.2.1 Advantages are:

- (a) Allows excellent lateral placement.
- (b) Provides good visibility from stop-line.
- (c) May provide side-mount locations for supplementary signals or pedestrian heads and push buttons.
- (d) Generally accepted as an aesthetically pleasing overhead mounting.
- (e) Rigid mountings provide positive control of signal movement in wind.

#### 4.7.2.2 Disadvantages are:

- (a) Costs are higher than other mounting alternatives.
- (b) On very wide approaches it may be difficult to properly place signal heads over the lanes they control.

### 4.7.3 Span-Wire (Catenary) Mounted Signals

In a span-wire installation, all or most of the traffic signal heads are mounted overhead. In this application, strain poles (with climbing rung) are installed at two or more locations at the intersection, a support cable is strung between the poles, and signal heads are attached along the support cable. Wiring is run overhead along the support cable to the signal heads.

The signal heads shall be able to move to the strain pole by means of manual or motorized winch. The bottom of the signal heads shall be at a minimum height of 6.5m from the surface of the road.

Design of span-wire installations shall cater for: -

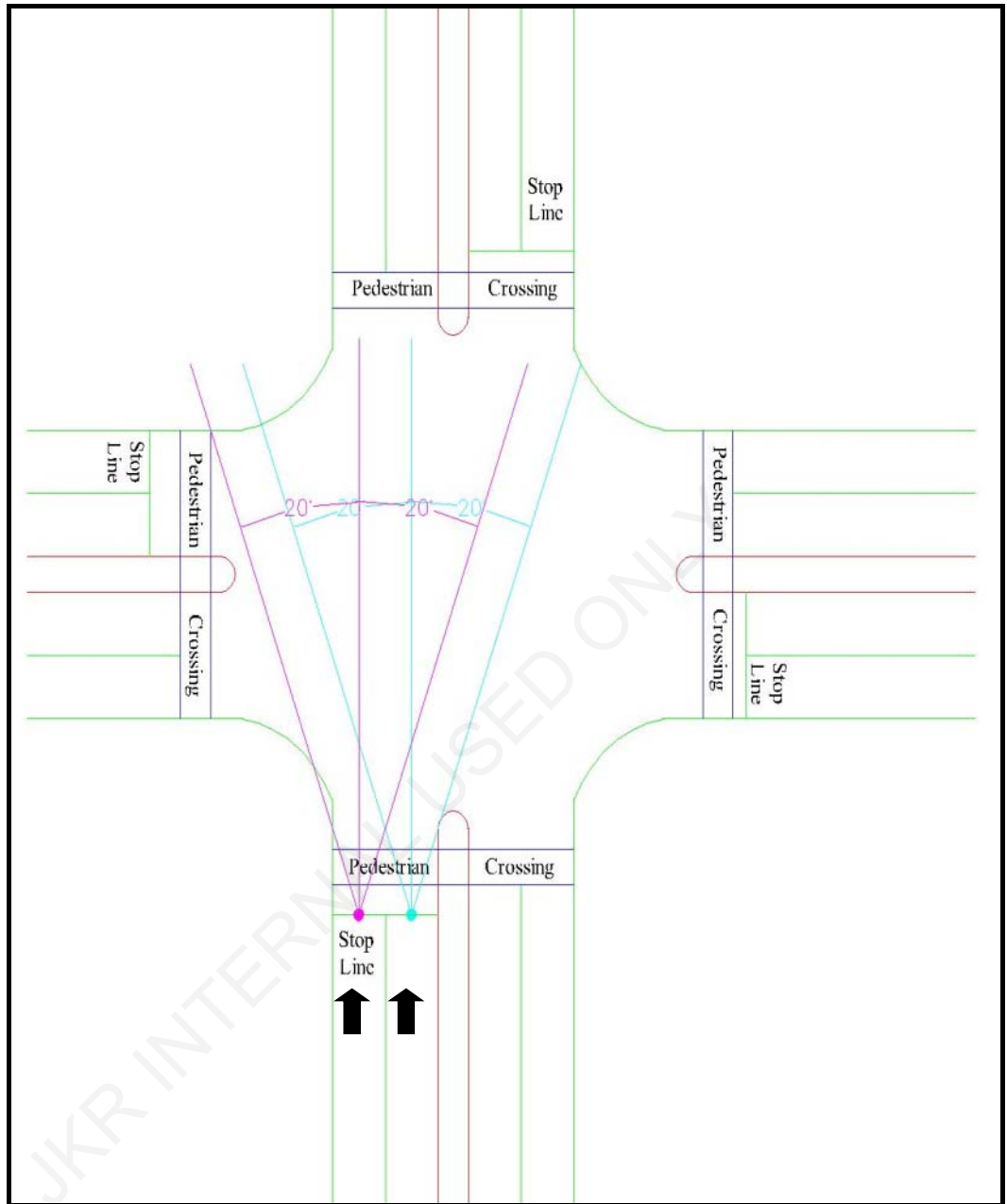
- (a) wind speed of 35m/s
- (b) sagging of catenary wire/line
- (c) safety of the road users
- (d) category of traffic
- (e) terrain of the road

4.7.3.1 Advantages are:

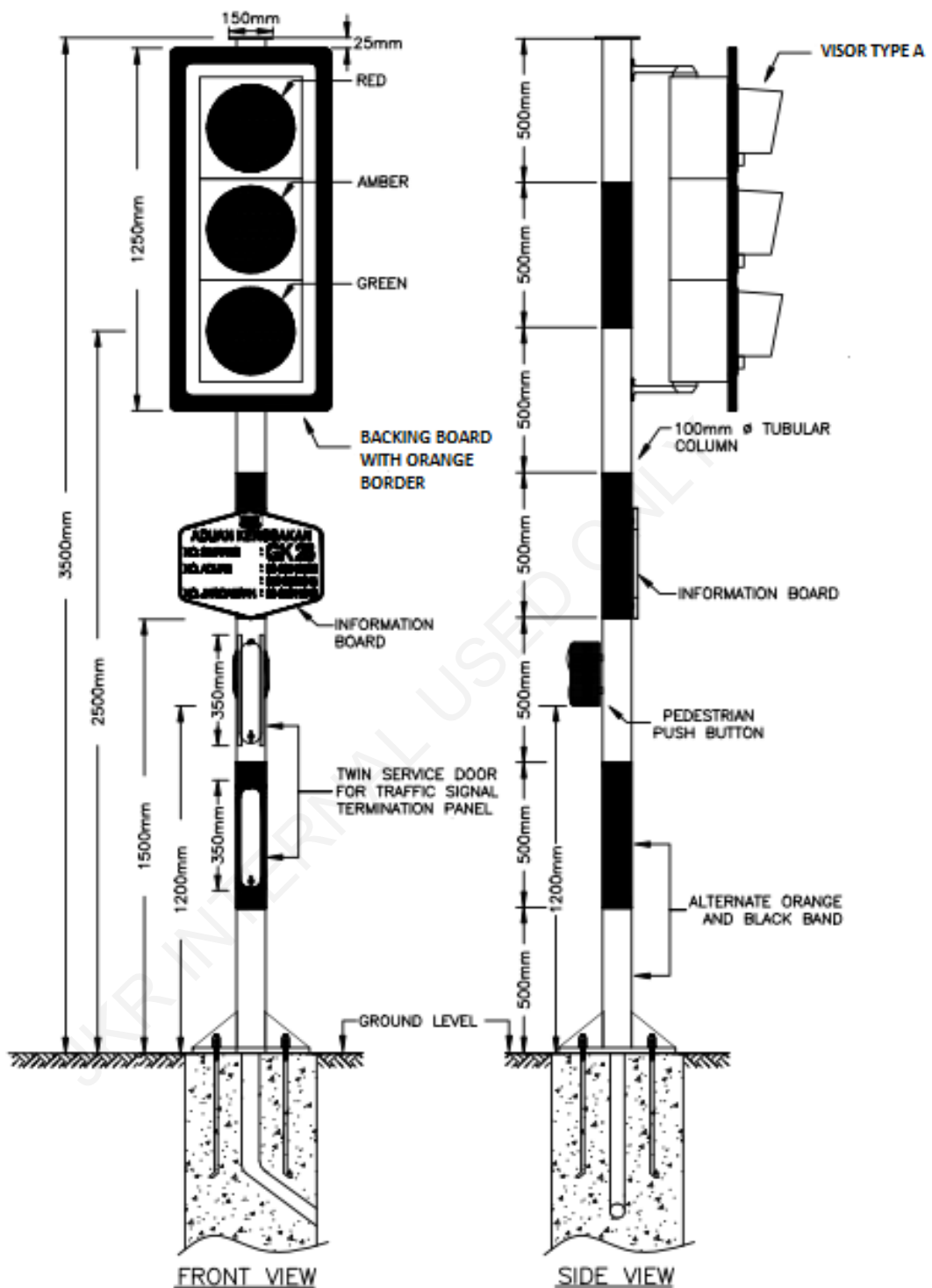
- (a) Allows good lateral placement of signals for maximum conspicuity.
- (b) Minimum number of poles to clutter sidewalk area.
- (c) Easy to install, little or no underground work required.
- (d) May be combined with utility poles.
- (e) safer to maintain at the side of the road

4.7.3.2 Disadvantages are:

- (a) Visibility from stop line is improved with secondary aspects mounted ahead of stop line.
- (b) Spans can be supported by GI or concrete catenary poles.
- (c) All aspects are located on one span maximizing loading on cable and poles.
- (d) Aspects can be mounted on mounting span and guided using a separate catenary span. Guide rail spans reduce aspect sway. Additional support spans can be placed to reduce sag of catenary wire if spans are too long.
- (e) Often considered unpleasing aesthetically because of head "clutter"
- (f) Poor pedestrian visibility of indications.
- (g) No provision for serving all corners with pedestrian push button
- (h) Higher risk when accident occur (single point of failure)

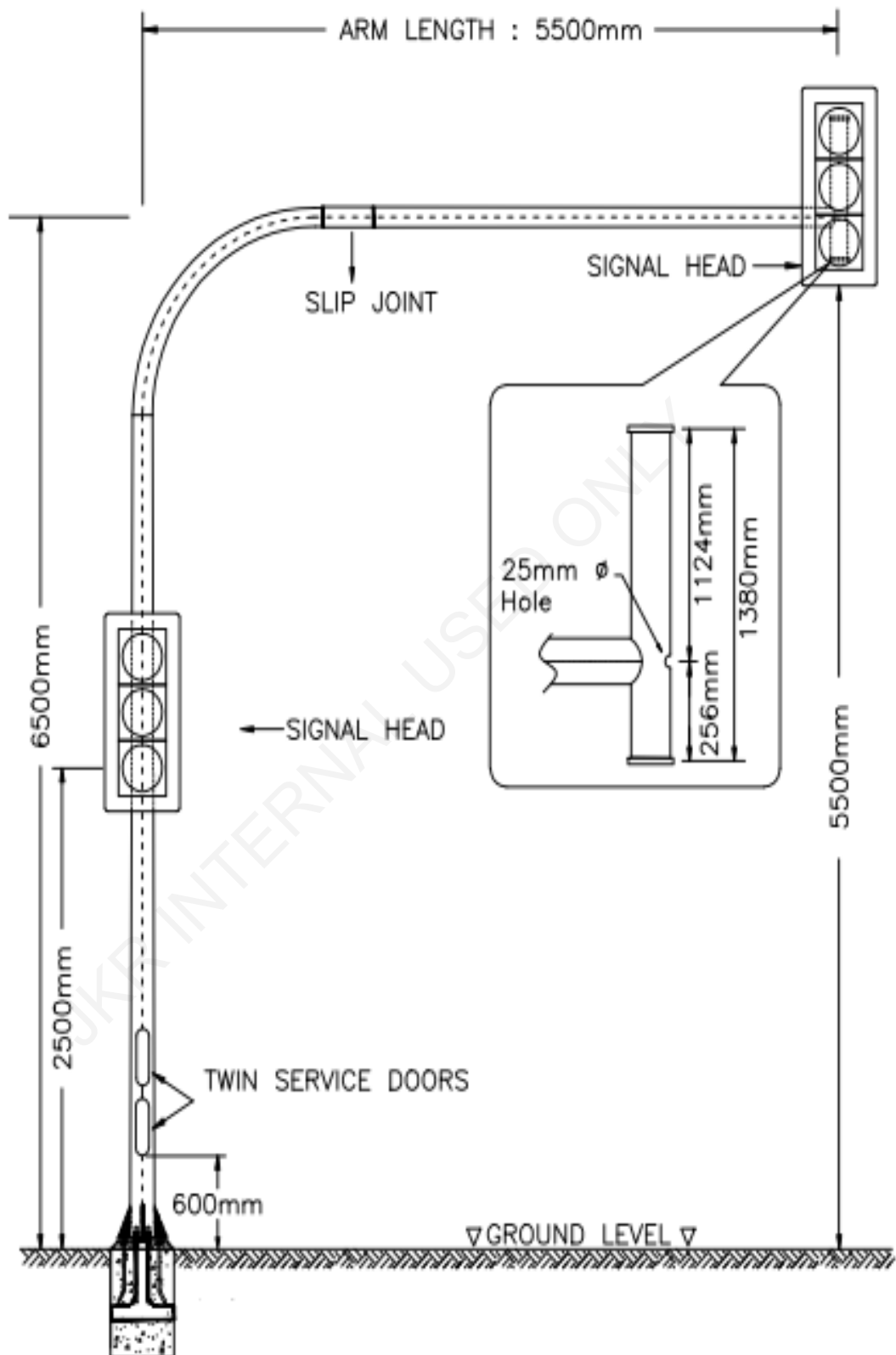


**FIGURE 4.1: CONE OF VISION**



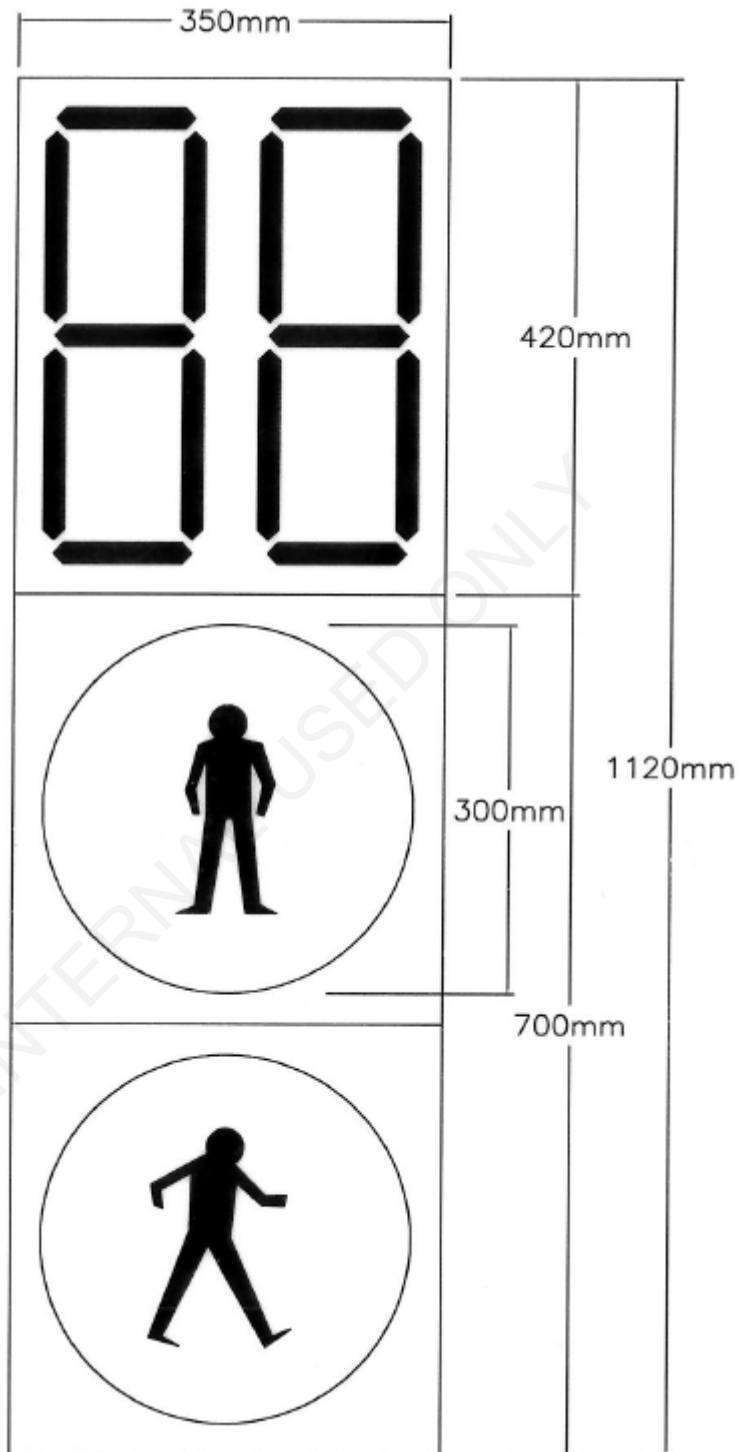
**FIGURE 4.2: HEIGHT OF COLUMN MOUNTED SIGNAL HEAD**

Source : Standard Drawings for Road Works Section 8: Traffic Signal System



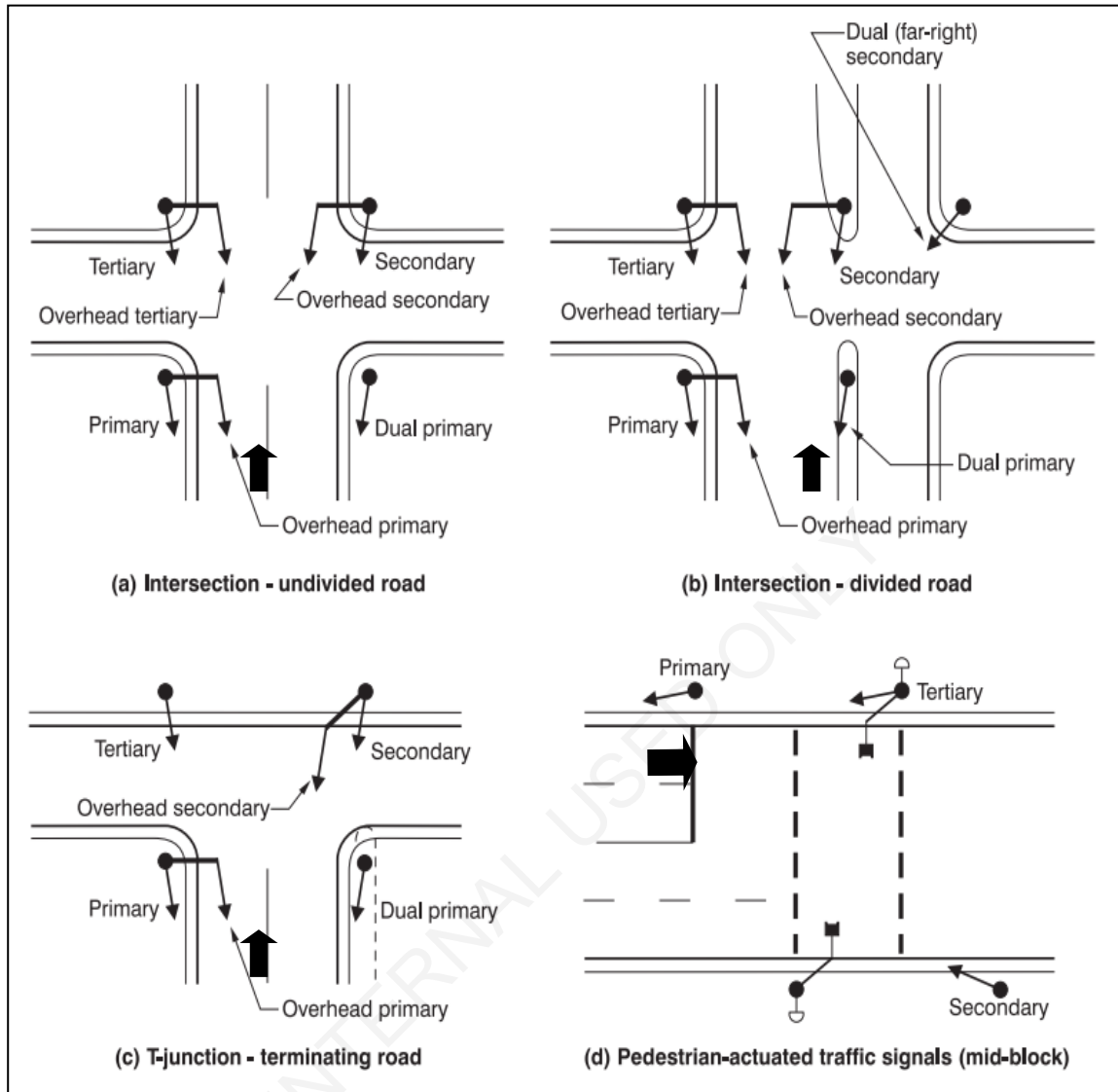
**FIGURE 4.3: HEIGHT OF MAST ARM MOUNTED SIGNAL HEAD**

Source : Standard Drawings for Road Works Section 8: Traffic Signal System








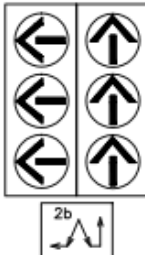
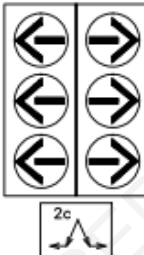



**FIGURE 4.4: DIMENSIONS AND SIGNAL INDICATION FOR COLUMN MOUNTED PEDESTRIAN SIGNAL HEAD**

*Source : Standard Drawings for Road Works Section 8: Traffic Signal System*



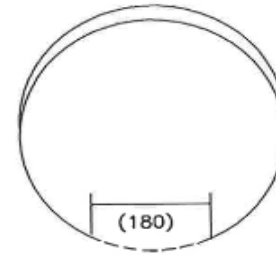
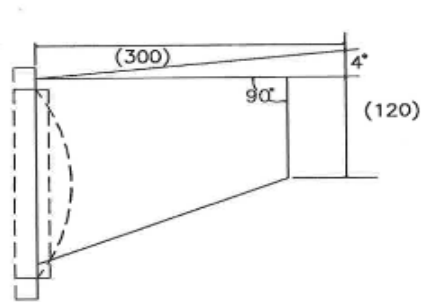
**FIGURE 4.5: THE DESIGNATION OF SIGNAL HEAD FOR DIFFERENT TYPES OF JUNCTION**



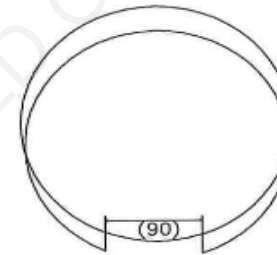
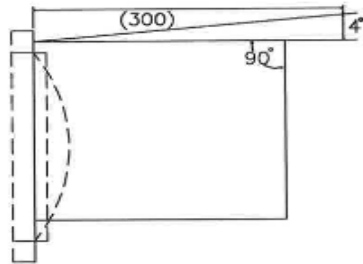
 <p>TYPE 1a – 3 X 300mm HIGH POWERED LED TYPE WITH FULL RED, FULL AMBER AND FULL GREEN</p>	 <p>TYPE 1b – 3 X 300mm HIGH POWERED LED TYPE WITH STRAIGHT AHEAD RED ARROW, STRAIGHT AHEAD AMBER ARROW AND STRAIGHT AHEAD GREEN ARROW</p>	 <p>TYPE 1c – 3 X 300mm HIGH POWERED LED TYPE WITH RIGHT TURN RED ARROW, RIGHT TURN AMBER ARROW AND RIGHT TURN GREEN ARROW</p>	 <p>TYPE 1d – 3 X 300mm HIGH POWERED LED TYPE WITH LEFT TURN RED ARROW, LEFT TURN AMBER ARROW AND LEFT TURN GREEN ARROW</p>
 <p>TYPE 2a – 6 X 300mm HIGH POWERED LED TYPE WITH 3X300mm STRAIGHT AHEAD RED ARROW, STRAIGHT AHEAD AMBER ARROW AND STRAIGHT AHEAD GREEN ARROW AND 3X300mm RIGHT TURN RED ARROW, RIGHT TURN AMBER ARROW AND RIGHT TURN GREEN ARROW</p>	 <p>TYPE 2b – 6 X 300mm HIGH POWERED LED TYPE WITH 3X300mm LEFT TURN RED ARROW, LEFT TURN AMBER ARROW AND LEFT TURN GREEN ARROW AND 3X300mm STRAIGHT AHEAD RED ARROW, STRAIGHT AHEAD AMBER ARROW AND STRAIGHT AHEAD GREEN ARROW</p>	 <p>TYPE 2c – 6 X 300mm HIGH POWERED LED TYPE WITH 3X300mm LEFT TURN RED ARROW, LEFT TURN AMBER ARROW AND LEFT TURN GREEN ARROW AND 3X300mm RIGHT TURN RED ARROW, RIGHT TURN AMBER ARROW AND RIGHT TURN GREEN ARROW</p>	
 <p>TYPE 3a – 2 X 300mm HIGH POWERED LED TYPE WITH RED MAN STANDING AND GREEN MAN WALKING (COMPLETE WITH COUNTDOWN DISPLAY AND BUZZER)</p>			
 <p>TYPE 4a – 1 X 300mm HIGH POWERED LED TYPE WITH STRAIGHT AHEAD GREEN ARROW FOR FREE FLOW LANE</p>	 <p>TYPE 4b – 1 X 300mm HIGH POWERED LED TYPE WITH FULL AMBER FOR FLASHING AMBER PURPOSE</p>		

**FIGURE 4.6: TYPICAL ARRANGEMENTS OF SIGNAL ASPECTS IN SIGNAL HEAD**

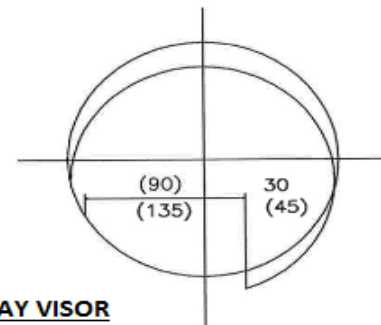
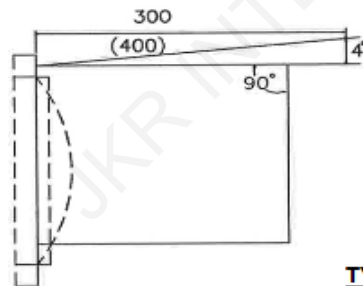
Source : Standard Drawings for Road Works Section 8: Traffic Signal System



**TYPE A - OPEN VISOR**



**TYPE B - CLOSED VISOR**



**TYPE C - CUT AWAY VISOR**

**FIGURE 4.7: DIFFERENT TYPE OF VISORS FOR SIGNAL ASPECT**

## CHAPTER 5: TRAFFIC SIGNAL CONTROLLERS AND DETECTORS

The designer should decide on the types of control required in the traffic system. It is recommended to use vehicle actuated control type. The designer has to further decide on the type and location of the vehicle detectors required.

The types of signal operation requirement have been discussed in Chapter 3.

### 5.1 General

Traffic controller is the traffic light sequence controller, which will be located at the junction of crossroads. It is to ensure:

- (a) Safety of the vehicle movement at the traffic junctions.
- (b) Smooth traffic flow by means of strategic traffic light control of timing and sequence.
- (c) Optional facility for remote monitoring, controlling and management.

Traffic signal controller can be classified into either fixed time or actuated and shall be microprocessor-based. Semi-actuated, full actuated, and volume-density modes can be provided within the basic actuated controller unit.

The traffic controller must be able to communicate over public switched telephone network (PSTN) dial up line, leased line, ADSL/SDSL line, private wireless networks, fiber optic and satellite networks. This will enhance the smart monitoring fault detection system, because traffic controller would be able to analyze and determine the seriousness of the malfunction at the traffic light system and send alerts via registered social media applications. Telegram is one of social media applications which could be implemented. When a fault is detected in any of the traffic light system, the centralized controller receives the signal then analyses and send an alert via messaging system to the nearby monitoring station or via internet to any Telegram group as programmed in the system. The entire process will be functioning with no human intervention at all.

Additionally, independent power back up (i.e. Uninterrupted Power Supply (UPS)) is essential for signalized intersection, which could experiences power outages due to various reasons. This could help traffic controller continue to operate even during a power failure securing the public safety and eliminates the need to dispatch police or other service personnel to direct the traffic.

### 5.2 Fixed Time Controllers

This type of controller operates according to a predetermined cycle lengths and phase intervals. It is frequently used when there are predictable and stable traffic volumes. It provides a simple, economical means of traffic control and thus, it is reliable and relatively easy to maintain.

For traffic volume with distinct peak and non-peak hours, different fixed time plans can be programmed by means of multiplan system.

Multiplan controller is not suitable for roads with high degree of variability in the traffic flows because it does not recognize or accommodate short-term fluctuations in traffic demand and can cause delay to vehicles and pedestrians. Fixed time Multiplan can be used as a temporary control during failure or breakdowns. It allows the traffic system to function while awaiting full recovery of the traffic controller.

### 5.2.1 Timing Characteristics

Fixed time controllers have the following characteristics from a timing standpoint:

- (a) Provide a fixed amount of time for each phase interval
- (b) Each phase or movement can be divided into a number of discretely timed intervals such as phase green, flashing walk, amber change and all red clearance. The same timing is provided for each of these intervals regardless of demand.

Fixed time controllers do have a degree of flexibility in varying timing. Changes in timing can be accomplished to provide different cycle lengths, interval timing, and/or offset. Timing plans are usually selected on a time-of-day/day-of-week basis by means of time clock.

There are two types of fixed-timed signals:

#### (a) Fixed time Signal Controller

Fixed time signal controllers are 4 signal group controllers which provide up to 4 phases of vehicle flow per junction. Timings are predetermined and cannot be changed throughout the day or week.

#### (b) Multiplan Time Signal Controllers

Multiplan Time Signal Controllers are also 4 signal group controllers providing up to 10 phases of control per junction. Although timings are pre-determined, the Multiplan controllers are able to carry up to 16 different time plans per day of every day of the 7 days per week. This means that in each day, 16 time slots may exist with different timings specified for each phase. Such timings may be sourced from a pre-existing actuated controller which has this data or a centralized area traffic control system which has this data or it can be input manually, the former being the preferred method of specifying the time plans.

### 5.3 Vehicle Actuated Controllers

A vehicle-actuated (VA) controller operates with variable timing and phasing intervals which depends on traffic volumes or pedestrians. The flows are determined by vehicle detectors within the roadway or by actuation of pedestrian push buttons. The basic applications of actuated control include:

- (a) Semi-actuated
- (b) Full-actuated
- (c) Volume-density

#### 5.3.1 Semi-Actuated Controllers

These devices provide the mean for traffic actuation on one or more, but not all of the intersection approaches. It is applicable primarily to an intersection of a heavy-volume; urban or suburban **arterial road** with a low-volume minor road.

The essential operating features of the controller are:

- (a) Detectors are only on minor approaches road only.
- (b) Major road receives minimum **green interval** in each cycle. Green interval shall have a preset minimum and maximum time limit.
- (c) Major road receives green indefinitely after minimum green interval, until interrupted by actuation of the minor vehicle detector.
- (d) Minor road changes to green interval after actuation, provided major road has completed its minimum green interval.
- (e) Minor road receives minimum green-interval.
- (f) Minor road green is extended by additional actuations until preset maximum limit is reached or a gap in actuations occurs.
- (g) Additional actuation on minor road shall wait for the next green interval once the maximum limit has been reach.
- (h) Amber change and all-red clearance intervals are preset for each phase.

This kind of control is excellent for use where a minor road volume cannot safely cross major flows without signalization. If minor road flows are infrequent, the regular interruption of the major road flow with pre-timed control cannot be justified.

Where both road volumes fluctuate widely, semi-actuated control should not be used, since there are no detectors on one or more legs: -

- (a) Can be upgrade to be connected to an area traffic control system for centralized traffic coordination's.
- (b) This applies to underground loop detectors). Currently, numerous methods of vehicle detection exist such as video based detection, laser, radar and infrared and wireless inductive sensors exists which overcome this disadvantage.

### 5.3.2 Full-Actuated Controllers

These controllers provide for actuation by vehicle on all lanes of the intersection. It is applicable primarily to an isolated intersection (about 2.0km between adjacent signals) of roads that carry approximately equal traffic volumes, but where distribution between approaches varies and fluctuates. It then becomes necessary to take into consideration that demands on all approaches.

The essential operating features of the controller are: -

- (a) Detectors are installed on all approaches roads.
- (b) Each road has preset initial interval to provide starting time for stopped vehicle.
- (c) Green interval is extended up to preset maximum time limit, provided a gap in actuation does not occur.
- (d) Amber change and all-red clearance intervals are preset for each phase (no minimum and maximum limits).
- (e) Each phase has a recall/bypass switch
  - (i) When both recall/bypass switches are 'OFF', the green will remain on one phase when no demand is indicated on the other phase – Full VA.
  - (ii) When one recall/bypass switch is 'ON', the green will revert to that phase at every opportunity – Semi-Actuated
  - (iii) When both recall/bypass switches are 'ON', the controller will cycle on a fixed-time basis in the absence of demand on either phase (one initial interval and one vehicle interval on each phase) – Fixed Time

Because of their actuated nature, full-actuated controllers cannot be coordinated with other signals without losing the flexibility for which they were designed.

### 5.3.3 Volume-Density Controllers

This controller is applicable to an isolated intersection with wide traffic fluctuations between roads where green time is depends on the vehicle volumes on approach lanes. Volume-density signals are also able to record and retain information regarding volume, queue length and delay times.

Operating features of the controller are:-

- (a) Detectors are installed on all approaches roads.
- (b) Each volume density phase has an initial green time that can be varied by:

- (i) Preset initial interval
  - (ii) Adjustable extended initial interval
- (c) Passage time (time taken to travel from the detector to the stop line) is the extended green time created by each additional actuation after the initial green time has ended.
- (d) Passage time is reduced to a minimum gap after a preset time.
- (e) Maximum green  $\phi$ -limits (extension) are preset for each phase.
- (f) Amber change and all-red clearance intervals are preset for each phase.

The green phase will end by means of any one of these mechanisms: -

- (a) No *more* vehicles on the approach *lanes*.
- (b) The maximum green interval is reached.
- (c) The gap between vehicles on the approach lanes exceeds the maximum time gap.

The **maximum time gap** is the “density” function of the signal. It decreases as the green phase continues, for example, at the beginning of the green phase, the maximum time gap is 5 seconds which will reduce to 2 seconds as the green phase continues. The green phase ends when the maximum gap is exceeded, or when the maximum length of phase is reached, whichever comes first.

This type of control provides the greatest flexibility in vehicle-actuated controllers, as it is capable of taking into consideration the volume of vehicles on an approach lane.

#### 5.4 Controller Location

The traffic signal controller shall be housed in weatherproof console cabinet (IP55) with anti-sticker paint. It shall be located where: -

- (a) Power supply can be obtained.
- (b) The cabinet shall not obstruct the pedestrian right of way.
- (c) The cabinet shall not be installed within the clear zone which could expose to accidental damage caused by passing traffic.
- (d) The cabinet shall not obstruct the view of all approaches to the intersection in the event of manual operation. When this condition cannot be satisfied and manual operation is frequently required, a portable unit shall be provided.
- (e) The cabinet front and rear door can be opened in full without any obstruction.
- (f) The cabinet orientation shall be in perpendicular to the roadways in order to minimize vandalism.
- (g) The 600mm paved platform shall be provided in front and rear of the concrete plinth cabinet to facilitate maintenance.

## 5.5 Detectors

Traffic detectors are a primary requisite of actuated signal controls as they sense vehicle or pedestrian demand (pedestrian push-button) and relay these data to the local intersection controller and/or master controller so that the appropriate signal indications may be displayed. The selection of detectors (type, design, and installation) depends on the requirements and physical layout of the intersection.

### 5.5.1 Types and Functions of Vehicle Detectors

Earlier detectors that have been used include pressure pads, radar, and sonic detectors. Their use is now very limited. New installations use various types of detectors such as inductive loop detectors, cameras, or radars (infra-red or microwave or laser). The physical design and construction of these commonly used detectors are summarized below:-

(a) **Inductive Loop Detector:** It is the most commonly used today and is the most economic form of detection. This detector consists of a loop which has one or more turns of sensor cable (average of 5 loops) in a saw-cut slot on the road surface at the exact area where vehicles are to be detected. The ends of this loop are connected to a detector card located in the controller. A vehicle passing over, or resting within the loop, will unbalance a tuned circuit which is sensed by the detector card.

(b) **Camera Detector**

Video based vehicle detection technology is an integral part of traffic control systems, due to its non-intrusiveness and comprehensive vehicle behavior data collection capabilities. The system can conduct vehicle presence detection, classification, counting, speed detection, red light violation and incident management data. The performance of the video based system is equivalent to radar based detection but requires video calibration in daylight, night, rain and haze conditions for optimal detection. It offers a much greater amount of data which can be used for VA algorithm improvement such as incorporating queue detection, headway measurement, greenwave based on average speed and much more. The requirements of a viable and compatible camera must be met to ensure successful operation. It is suitable for up to 8 lanes detection if mounted on an overhead pole and lower number of lanes if mounted on a vertical pole.

Red light violation and speed cameras are effective to reduce crashes at high-risk signalized intersections. Red-light violation cameras detect vehicles travelling over the stop line or entering an intersection once the light turns red, while speed cameras takes a digital picture of the offending vehicle when the speed of a vehicle exceeds a preset limit. Both are very useful in the Intelligent Traffic System environment.



- (c) Radar
  - (i) Radar detectors operate on the Doppler Effect. Microwaves are beamed toward the roadway by a transmitter. A vehicle passing through this beam reflects the microwave back to the antenna denoting the motion of a vehicle.
  - (ii) Radar - laser  
The high-intensity light detector is a special purpose detector system used for priority control for emergency and transit vehicles. It utilizes a high-intensity light emitted at a specific frequency from a transmitter mounted on the vehicle and a detector mounted on or near the traffic signal. When the light from an emergency or priority vehicle is detected, the detector relays a signal to a phase selector connected to the controller. However, this type of detector has never been used in this country.
  - (iii) Radar and Infrared Detector  
Radar and infrared detectors operate on the Doppler and infrared effect. Microwaves are beamed toward the roadway by a transmitter. A vehicle passing through this beam reflects the microwave back to the antenna denoting the motion of a vehicle (during the green phase). For presence detection, the radar and infrared detector uses its infrared component. Since stationary vehicles (usually in the red phase) are invisible to radar, the infrared detector detects the vehicle and sends the signal output to the traffic controller. It has a dynamic range of approximately 5-15 meters and is suitable for up to 2 lanes detection.

### 5.5.2 Application of Vehicle Detectors

Detector location and configuration depends on:-

- (a) Type and capability of controller
- (b) Control mode
- (c) Traffic variable to be measured
- (d) Geometry of the intersection and approaches
- (e) Traffic flow characteristics (e.g: volume, speed, etc.)

**Short loop detectors** (for single lane loop) constitute the simplest and most widely used type of detector application. This short loop configuration is intended to detect a vehicle upstream of the stop line. When a vehicle passes over the detector, a “call” is placed and the controller responds as programmed.

Short loop detectors may be located at varying distances upstream of the stop *line* depending on the operational requirements. However, this may vary in practice depending on the approaching vehicle speed.

**Long loop detectors** can also be used. It is a presence detector that registers the presence of a vehicle in the zone of detection as long as the detector is occupied.

### 5.5.3 Detection of Small Vehicles

A presence detector should be able to detect all motor vehicles and hold its call until the display of a green to the phase. A hold time of 3 minutes is commonly specified. A detection loop configuration longer than 6 meter may not detect a small motorcycle.

## 5.6 Location Of Detectors

The primary detector location should consider the speed, type, and volume of approaching vehicles as well as the type of controller unit. **TABLE 5.1** presents a range of suggested detector setbacks. The values are determined as a function of deceleration rate, reaction time, and deceleration distances.

The detectors requirements for low-speed approaches differ from the requirements associated with high-speed approaches. Controllers shall be able to detect and identify detector position and its associated phase. With this capability, it is sufficient for a low-speed approach or an urban condition approach to install just one detector. This secondary detector should be placed about 30m upstream of the stop line. Adjustment to the variable Initial Green Time can accommodate the traffic built up at the stop line during the red interval. This facility shall be made available.

**TABLE 5.1: SAFE STOPPING DISTANCE AND DETECTOR SETBACK**

Deceleration rate, d	=	3.28 m/s <sup>2</sup>
Deceleration time, t	=	V/d. seconds
Speed, V	=	m/s
Reaction time, r	=	1 second
Reaction Distance, R	=	r x V meter
Deceleration distance, D	=	1/2 (V x t) meter
Safe Stopping Distance, S	=	R + D meter
	=	r x V + 1/2 (V x t)

Speed (km/h)	V (m/s)	Decel. Time, t (secs)	Reac. Dist., R (meter)	Decel. Dist., D (meter)	Total Dist., S (meter)	Detector Setback (meter)
24	6.7	2.20	6.7	7.4	14.1	14
32	8.9	2.93	8.9	13.1	22.0	22
40	11.2	3.67	11.2	20.5	31.8	32
48	13.4	4.40	13.4	29.5	42.9	43
56	15.6	5.13	15.6	40.1	55.7	56
64	17.9	5.87	17.9	52.5	70.4	70
72	20.1	6.60	20.1	66.4	86.5	*
80	22.3	7.33	22.3	81.9	104.2	*
88	24.6	8.07	24.6	99.2	123.8	*
96	26.8	8.80	26.8	118.0	144.8	*
105	29.0	9.53	29.0	138.4	167.5	*

\* Use multiple detectors.

## 5.7 Installation Considerations

### 5.7.1 Loop Detectors

To operate effectively, detectors must be properly designed and carefully installed. An improperly installed detector can seriously degrade the efficient operation of the controller or even render the controller inoperative.

The inductive loop detector wire is normally a 2.5mm<sup>2</sup> single core 50 strands heat resistance cable, or 20 AWG Fluorinated Ethylene Propylene (FEP) cable (18 strands copper conductor with 0.18mm diameter) embedded in a saw-cut slot approximately 75mm below the road surface. A sealant such as asphalt, epoxy, polyurethane, or polyester compounds, is used to seal the loop in the pavement. An alternative and more durable construction is to place the turns of wire in a plastic conduit within or just below the pavement surface or within a plastic sleeve laid in the saw-cut in the pavement.

The width of the single lane loop shall be minimum 1m while the length can range from 2m to 3m. The effective area of detection normally extends about 0.75 meter outside the loop.

The distance of the loop detector from the edge line and lane marking shall not be less than 300mm.

Single lane loop detector is preferred over multi-lane loop detector (very large loops) and shall operate independently. This is to ensure that the detection system works should either one of the loops malfunction.

### **5.7.2 Camera Detectors**

Camera based detectors are installed using a CCTV camera which is connected to a video image capture module. CCTV camera is mounted on an overhead pole with a view of the stop line and at least 3 vehicles from the front line. Coverage should be as wide as possible and careful measures to avoid sun glare or obstructions should be taken. Cameras connected to the video image module using CAT6/CAT5 cables with or without power over Ethernet (POE) capabilities. Video image modules are housed in the traffic controller which capture the image and convert the video / image streams into detection outputs. Calibration and designation of loops is conducted upon testing and commissioning of the traffic controller.

### **5.7.3 Wireless Radar and Infrared**

Wireless radar and infrared detectors are mounted on vertical poles. The coverage is approximately 2 lanes and careful measures to calibrate the detectors to ensure no overlapping detection zones should be taken. Calibration is possible by tilting, adjusting the angle and focus of the radar and infrared detector. The system should be tested with vehicles in motion and stationary vehicles to ensure both functions send a detection signal to the controller. For high speed roads (>80km/h), the wireless radar needs to be calibrated well to ensure optimal detection.

### **5.7.4 Laser Based Detectors**

Laser based detectors function with a longer dynamic range and the ability to detect fast moving vehicles. It can be mounted on vertical and overhead poles and has a detection range of up to 3 lanes.

## **5.8 Considerations**

Additionally, traffic adjusted systems which are coupled with vehicle actuated traffic system are able to more effectively manage and coordinate intersections of varying traffic patterns. Timings can be specified as vehicle actuated maximums and green wave link coordination's can be conducted locally by controller to controller coordination as well as centralized control coordination's. Today, traffic adjusted systems are more commonly known as urban traffic control or area traffic control centers. Numerous systems exist and they are compatible with specific brands or able to upload and download data through recognized protocols of communication. This traffic control center able to act as a hub which communicates with individual traffic controllers on site. The communication can be established via WiFi, 3G/4G, Leased Line or Fiber optics mediums. This types of control center collect and store data from each controllers. The data will be processed and based on this, decision will be made and transmit to on-site

controllers. These days most of control center use cloud services for their servers and databases. Among few features of control center are:

- (a) Real time monitoring of the junction
- (b) Receive alerts from controller on site
- (c) Traffic data collection and analysis
- (d) Link the adjacent controllers
- (e) Implement maximum green time automatic revision VA algorithm and optimize fixed time algorithm when needed.
- (f) Remote Police Control/ priority / pre-emption capability.

The advantages of traffic adjusted systems include: -

- (a) Efficient coordination of traffic controllers on site
- (b) Automatic timing adjustment of VA controllers based on ineffective regular use of junction and low junction throughput analysis.
- (c) Automatic phasing adjustment and recommendations based on ineffective or inefficient regular use of junction and low junction throughput analysis.
- (d) Data logging of controller faults and alerts to control centre via pop up messages, SMS alerts, email are all possible
- (e) Maintenance management of traffic controllers becomes highly efficient.
- (f) Suitable for urban areas or areas which require coordination of traffic junctions with high vehicle throughput.

The disadvantages of traffic adjusted systems include: -

- (a) Cost of implementing is considerable
- (b) Area to be connected to a single system must have uniform brands of traffic controllers to ensure successful communication to a control centre platform
- (c) Maintenance and optimization of the system requires highly skilled expertise usually only available in suppliers talent pool and not in government agencies.
- (d) Cost of maintenance involves subscription cost to telecommunication providers such as GSM 3G data cost, leased lines, fibre optic leasing or WIFI leasing. This cost can be offset if the communication equipment is owned by the government agency or dedicated to the traffic system use.

## CHAPTER 6: TRAFFIC SIGNAL TIMING

### 6.1 Objective

The objective of signal timing is to alternately assign the right-of-way to various traffic movements (phases) in such a manner as to minimize average delay to any single group of vehicles or pedestrians and to reduce the probability of accident producing conflicts.

The subchapters of Chapter 6 are a summary from Malaysian Highway Capacity Manual 2006 and USA Highway Capacity Manual 2000 and 2010. These manuals shall be referred to in order to obtain more detailed information regarding these subchapters.

The following equations and calculations present the manual calculation method of determining the signal timing and resulting Delay and Level of Service. However, the use of software are also acceptable for these means when the software can be shown to be able to be calibrated to local conditions and are able to closely replicate existing conditions for the junction or analysis in question.

### 6.2 Design Principles

#### 6.2.1 Determination of Flow Rate, $v_p$

A peak 15-minutes flow rate ( $v_p$ ) is derived from an hourly volume by dividing the movement volumes ( $V$ ) by an appropriate Peak Hour Factor (PHF), which may be defined for the intersection as a whole, for each approach, or for each movement. The flow rate is computed by: -

$$v_p = \frac{V}{PHF} \quad \text{Eq 6.1}$$

The conversion of hourly volumes to peak flow rates using PHF assumes that all movements peak during the same 15-minutes period. So, it is valuable to observe 15-minutes flows directly and select the critical periods for the analysis.

#### 6.2.2 Determination of Saturation Flow Rate, $S$

Saturation flow rate under prevailing conditions is estimated using equation. The ideal saturation flow rate for Malaysian road condition is 1930 passenger cars per hour of green. The ideal saturation flow is adjusted to take into consideration non-ideal condition.

$$S = S_o \times N \times f_w \times f_g \times f_a \times f_{LT} \times f_{RT} \times (1/f_c) \quad \text{Eq 6.2}$$

where

S	=	Saturation flow rate under prevailing conditions (vehicle per hour of effective green time)
S <sub>o</sub>	=	Ideal saturation flow rate which is <b>1,930</b> passenger cars per hour of green time per lane.
N	=	number of lanes in the lane group
f <sub>w</sub>	=	adjustment factor for lane width (3.66 meter is the standard lane width)
f <sub>g</sub>	=	approach grade adjustment factor
f <sub>a</sub>	=	area type adjustment factor
f <sub>RT</sub>	=	right turning in the lane group adjustment factor
f <sub>LT</sub>	=	left turning in the lane group adjustment factor
f <sub>c</sub>	=	vehicle composition correction factor (f <sub>car</sub> + f <sub>HV</sub> + f <sub>motor</sub> )
f <sub>HV</sub>	=	adjustment factor for heavy vehicles (any vehicle having more than four tires touching the pavement)
f <sub>car</sub>	=	adjustment factor for passenger cars
f <sub>motor</sub>	=	adjustment factor for motorcycles

#### 6.2.2.1 Lane Width Adjustment Factor, f<sub>w</sub>

The lane width adjustment factor, f<sub>w</sub>, accounts for the narrowing effect of lanes on saturation flow rate and allows for an increased in flow rate, due to wider lanes. Lane width adjustment factor is obtained through the equation below:

$$f_w = 1 + \frac{w - 3.66}{3.663} \quad \text{Eq 6.3}$$

where w is the average lane width

#### 6.2.2.2 Grade Adjustment Factor, f<sub>g</sub>

Approach grade adjustment factor is separated into uphill and downhill gradient adjustment factor. The computation of grade adjustment factors are shown below for downhill and uphill gradient, respectively.

Downhill gradient adjustment factor,

$$f_g = 1 - \frac{G}{26.34} \quad \text{Eq 6.4}$$

Uphill gradient adjustment factor,

$$f_g = 1 - \frac{G}{14.39} \quad \text{Eq 6.5}$$

where G is the gradient in percentage

Note: These formulas are only applicable for gradient from -5.24% to 3.49%.

#### 6.2.2.3 Area Type Adjustment Factor, f<sub>a</sub>

The corresponding area type adjustment factor for CBD and non CBD areas in Malaysia is 0.8454 and 1.0000 respectively. The

area type adjustment factor takes into consideration relative inefficiency of signalised intersection located at the CBD as compared to other area. According to US HCM 2000, CBD or Central Business District can be described if the following condition is satisfied:

- (a) Narrow street right-way
- (b) Frequent parking maneuvers
- (c) Vehicle blockage
- (d) Taxi and bus activity
- (e) Small radius turns
- (f) Limited use of exclusive turn lanes
- (g) High pedestrian activity
- (h) Dense population
- (i) Mid-block curb cuts

**TABLE 6.1: ADJUSTMENT FACTOR FOR AREA TYPE,  $f_a$**

Type of area	Area type factor, $f_a$
<b>CBD</b>	0.8454
<b>NON CBD</b>	1.000

#### 6.2.2.4 Left Turn Adjustment Factor, $f_{LT}$

The mode of turning operations is significant to calculate the impact of saturation flow rate. It depends whether the lane is made for exclusive or shared lane, type of signal phasing and the proportion of left turning in shared lane. The Left Turn Adjustment Factor is computed according to the formula shown in Table 6.2 below based on the lane type.

**TABLE 6.2: ADJUSTMENT FACTOR FOR LEFT TURN ( $f_{LT}$ )**

Case / Lane Type	Left Turn Adjustment Factor ( $f_{LT}$ )
<b>Exclusive</b>	0.76
<b>Shared</b>	$1.0 - 0.243P_{LT}$

Note:  $P_{LT}$  = Proportion of left turn in lane group

#### 6.2.2.5 Right Turn Adjustment Factor, $f_{RT}$

Similarly, right turns may be operated in either an exclusive or shared lane; the signal phasing can be either permitted or protected. Most common signalised intersections setting in Malaysia are shared or exclusive lane with protected signal phasing. Table 6.3 below shows the adjustment factor for right turning at a signalised intersection.



**TABLE 6.3 : ADJUSTMENT FACTOR FOR RIGHT TURN ( $f_{RT}$ )**

Case / Lane Type	Right Turn Adjustment Factor ( $f_{RT}$ )
Exclusive	0.84
Shared	1 $1 + 0.195 P_{RT}$

Note:  $P_{RT}$  = Proportion of right turn in lane group

6.2.2.6 Vehicles Composition Correction Factor,  $f_c$

Vehicles composition correction factor ( $f_c$ ) is important in the analysis in order to reflect the composition of car, heavy vehicles and motorcycle at a signalized intersection.

$$f_c = f_{car} + f_{HV} + f_{motor} \quad \text{Eq 6.6}$$

$$f_{HV} = f_{trailer} + f_{bus} + f_{lorry} \quad \text{Eq 6.7}$$

where

$$f_{car} = e_{car} \left( \frac{Q_{car}}{V} \right)$$

$$f_{motor} = e_{motor} \left( \frac{Q_{motor}}{V} \right)$$

$$f_{trailer} = e_{trailer} \left( \frac{Q_{trailer}}{V} \right)$$

$$f_{bus} = e_{bus} \left( \frac{Q_{bus}}{V} \right)$$

$$f_{lorry} = e_{lorry} \left( \frac{Q_{lorry}}{V} \right)$$

**TABLE 6.4: PASSENGER CAR EQUIVALENT (PCE VALUES) FOR VEHICLES AT SIGNALISED INTERSECTIONS**

Vehicle Types	Passenger Car Equivalent ( $P_{ce}$ )
<b>Cars, <math>e_{car}</math></b>	1.00
<b>Motorcycles, <math>e_{motor}</math></b>	0.22
<b>Trailers, <math>e_{trailer}</math></b>	2.27
<b>Buses, <math>e_{bus}</math></b>	2.08
<b>Lorries, <math>e_{lorry}</math></b>	1.19

$Q_{car}$  = Total number of cars observed

$Q_{trailer}$  = Total number of trailer observed

$Q_{bus}$  = Total number of bus observed

$Q_{lorry}$  = Total number of lorry observed

$Q_{motor}$  = Total number of motor observed

$V$  = Total vehicles flow per hour

### 6.2.3 Signalised Intersection Flow Characteristics

For a given lane group at a signalized intersection, three signal indications are displayed: green, yellow and red. The red indication may include a short period during which all indications are red, referred to as an all-red interval, which with the yellow indication forms the change and clearance interval between two green phases.

### 6.2.4 Capacity Analysis and Determination of Level of Service (LOS)

The following sections involve a sequence of calculations to determine the capacity of the signalised intersection and the resulting Level of Service (LOS). The calculation of Capacity involves calculations of Lost time, Effective Green Time and Green Time Ratio.

The Level of Service, on the other hand is calculated based on the Intersection Delay which is a combination of Uniform Control Delay, Incremental Delay and Initial Queue Delay.

### 6.2.5 Determination of Lost Time, $t_L$ (s)

The lost time is

$$t_L (s) = I_1 + Y - e \quad \text{Eq 6.8}$$

$I_1$  = start loss (s)

$Y$  = Intergreen (s) = Amber + all red

$e$  = end gain (s)

### 6.2.6 Determination of Effective Green Time, $g$ (s)

The effective green time is calculated as below.

$$g = G + Y - t_L \quad \text{Eq 6.9}$$

$G$  = Actual green time

$Y$  = Amber + all red time

$t_L$  = Lost time

### 6.2.7 Determination of Green Ratio, $g/C$

The green ratio is the ratio of effective green time over the total cycle time.

$$\text{Green Ratio} = g/C \quad \text{Eq 6.10}$$

$g$  = Effective green time

$C$  = Cycle length

### 6.2.8 Determination of Lane Capacity, $c$ (veh/hr)

$$c \text{ (veh/hr)} = S (g/C) \quad \text{Eq 6.11}$$

$S$  = saturation flow rate (veh/hr)

$g$  = Effective green time

$C$  = Cycle length

### 6.2.9 Determination of Degree of Saturation, $X$ ( $v_p/c$ ratio)

$$X = v_p/c \quad \text{Eq 6.12}$$

$X$  = Degree of Saturation

$v_p$  = Adjusted flow rate (veh/hr)

$c$  = Lane capacity (veh/hr)

At this point, the critical lane groups and lost time per cycle can be identified. A critical lane group is defined as the lane group with the highest flow ratio in each phase of set of phases. If an overlapping phase occurs, all possible combinations of critical lane groups must be examined for the combination leading to the highest total of flow ratios to identify critical lane groups. Following which, the ratios of the critical groups are summed and used to compute the value of  $X$  (Degree of Saturation).

### 6.2.10 Determination of Flow Ratio, $y$

$$\text{Flow Ratio, } y = v_p/S \quad \text{Eq 6.13}$$

where

$y$  = ratio of flow to saturation flow

$v_p$  = Adjusted flow rate in veh/hr

$S$  = Saturation flow rate in veh/hr

The  $y$  value for a phase is the highest  $y$  value from the approaches within that phase.

For the whole junction,

$$y = \sum_{i=1}^n y_i$$

Eq 6.14

where

$n$  = number of phase

$y_i$  = highest  $y$  value from the approach within that phase  $i$ .

This  $y$  value is a measure for the occupancy of the intersection.  $y$  should preferably not be higher than 0.65. If the value found is higher than 0.85, it is recommended that the geometrics of the intersection be upgraded to increase the capacity.

### 6.2.11 Determination of Optimum Cycle Time, $C_o$

An expression for the optimum cycle time,  $C_o$  is given in Road Research Technical Paper No. 56 as

$$C_o = \frac{1.5L + 5}{1 - Y} \quad (\text{in seconds}) \quad (6.11)$$

This optimum cycle time,  $C_o$  gives the minimum average delay for the intersection. But this delay is not greatly increased if the cycle time varies within the range of 0.75 to 1.50 of the calculated  $C_o$ .

### 6.2.12 Determination of Signal Settings

Effective green time is the green time plus the change interval minus the lost time for a designated phase.

The total effective green time = cycle time minus total lost time.

$$g_1 + g_2 + \dots + g_n = C_o - L \quad (6.12)$$

where

$n$  denotes the number of phases

and  $g_n$  is the effective green time of phase  $n$ .  $n$  = the number of phases

$g_n$  = effective green time of phase  $n$

For optimum conditions

$$\frac{g_1}{g_2} = \frac{Y_1}{Y_2} \quad (\text{for a 2 phase cycle}) \quad (6.13)$$

With the above ratio, the following formulas apply to each individual phase.

$$g_n = \frac{Y_n}{Y} (C_o - L) \quad (\text{in seconds}) \quad (6.14)$$

where

$g_n$  = effective green time of the  $n^{\text{th}}$  signal phase  $n$

$Y_n$  = calculated  $Y$ -value of the same signal phase

For a 2 phase cycle

$$g_1 = \frac{Y_1}{Y} (C_0 - L) \quad (6.14a)$$

$$\text{And } g_2 = \frac{Y_2}{Y} (C_0 - L) \quad (6.14b)$$

$$\text{The actual green time, } G = g + l + R \quad (6.15)$$

$$\begin{aligned} \text{The controller setting time, } K &= G - a - R \\ &= g + l - a \end{aligned} \quad (6.16)$$

Therefore for a two-phase example

$$K_1 = g_1 + l - a \quad (6.16a)$$

$$\text{and } K_2 = g_2 + l - a \quad (6.16b)$$

### 6.2.13 Determination of Pedestrian Crossing Time

The calculation of the total Pedestrian Green Phase is critical in determining the maximum cycle lengths apart from the obvious safety concerns of facilitating sufficient crossing time for the pedestrians, The primary parameters to be considered in determining the length of the Pedestrian Green Phase are:

- (a) The average walking speed ( $V_p$ ) of pedestrians
- (b) The walking distance ( $D$ ) at the intersection where different formulas define the walking distance differently
- (c) A minimum walk interval time ( $W$ ) which should be added to the calculated pedestrian green phase which allows pedestrians adequate time to leave the curb and commence crossing. This can also be considered a safety factor to allow the pedestrian sufficient time to transverse the crossing. The MUTCD (Manual on Uniform Traffic Control Devices) and the ITE Traffic and Transportation Engineering Handbook recommends a minimum of 4 secs which can be increased to 7 secs if the average number of pedestrians crossing are more than 10 persons per cycle.
- (d) It is also recommended that the Amber phase of the pedestrian crossing be between 2 to 3 secs while the All Red Phase prior to the releasing of the vehicle movement be 3 secs.

The formula to calculate the length of the Pedestrian Crossing time provided by MUTCD is:

$$P_g = W + D_1/V_p$$

where;

- P<sub>g</sub> is the length fo the Pedestrian Green Phase
- W = minimum walk interval time
- D<sub>1</sub> = Walking distance at the intersection which is defined as from the centre of the corner radius (at the center of the intersection drop kerb or handicap ramp) to the centre of the furthest traffic lane.
- V<sub>p</sub> = Average pedestrian walking speed (assumed to be between 1.0m/s to 1.1m/s)

#### 6.2.14 Determination of Level of Service (LOS)

LOS at a signalised intersection is based on the average control delay per vehicle. When delays for each lane group and approach, including the intersection as a whole have been estimated, Table 6.5 below is used to determine the appropriate LOS.

**TABLE 6.5: LEVEL OF SERVICE FOR SIGNALISED INTERSECTION**

Level of Service	Control delay per vehicle (sec)
<b>A</b>	<= 10.0
<b>B</b>	>10.0 – 20.0
<b>C</b>	>20.0 – 35.0
<b>D</b>	>35.0 – 55.0
<b>E</b>	>55.0 – 80.0
<b>F</b>	>80.0

Source: US Source: US HCM 2000

Intersection LOS is directly related to the average control delay per vehicle. Once delays have been estimated for each lane group and aggregated for each approach and the intersection as a whole, Table 6.5 is consulted, and the appropriate LOS is determined. The result of an operational application of this method will yield two key outputs: volume to capacity ratios for each lane group and for all of the critical lane groups within the intersection as a whole, and average control delays for each lane group and approach and for the intersection as a whole along with the corresponding LOS.

Any v/c ratio greater than 1.0 is an indication of actual or potential breakdown (TRB, 2000). According to US HCM 2000, in such cases, it is advisable to make multi-period analysis. When intersection as a whole v/c ratio is less than 1.0 but some critical lane groups have v/c ratios greater than 1.0, it indicates that the green time is generally not appropriately

apportioned. So, analyst should attempt to retime the existing phasing in order to overcome such cases.

Under design intersection occurs when a critical v/c ratio is greater than 1.0. Analyst should look into the geometric design of the intersection, the timing and phasing of the traffic signal in order to make improvement. Note that such improvement must be notified to appropriate local authorities.

Delay could be higher even the v/c ratios are low. This is due to poor progression or incompatible cycle length or both. Such event will create an intersection with high delays without having a capacity problem. This is usually interpreted as an over design intersection. When the v/c ratio approaches or exceeds 1.0, it is possible for the over design intersection to have acceptable delays. For such cases, the analysis should consider the results of both the capacity analysis and the LOS analysis to obtain the complete picture of the existing signalised intersection.

### 6.2.15 Determination of Delay, d

Delay in the Levels of Service tabulated in Table 6.5 is the average control delay. In the LOS table, average control delay is estimated for each of lane group and averaged for approaches and the intersection as a whole. The average control delay per vehicle for a given lane group is given by equation below.

$$d = d_1 PF + d_2 + d_3 \quad \text{Eq 6.15}$$

Where:

- d = control delay (sec/veh)
- $d_1$  = uniform control delay (sec/veh)
- $d_2$  = incremental delay (sec/veh)
- $d_3$  = initial queue delay
- $PF$  = uniform delay progression adjustment factor  
which accounts for effect of signal progression
- X = v/c ratio for lane group
- C = cycle length (sec)
- c = capacity of lane group (vph)
- g = effective green time for lane group (sec)
- T = duration of analysis period
- k = incremental delay factor that is dependent on controller settings
- l = upstream filtering / metering adjustment factor

### 6.2.15.1 Uniform Control Delay, $d_1$

Assuming that the flow is stable and perfectly uniform arrivals, the equation below is used to calculate delay.

$$d_1 = \frac{0.5C \left(1 - \frac{g}{C}\right)^2}{1 - \left[\min(1, X) \frac{g}{C}\right]} \quad \text{Eq 6.16}$$

where

- X = v/c ratio for lane group; if the value of X exceeds 1, then a value of 1 should be used instead of the value of X
- C = cycle length (sec)
- g = effective green time for lane group (sec)

### 6.2.15.2 Progression Adjustment Factor, $PF$

The progression adjustment factor (PF) explains the impact of control type and signal progression on delay. Adjustment factor for Controller Type or Controller Type Adjustment Factor, CF is important to calculate the control delay.

**TABLE 6.6** shows the delay adjustment factor for different types of controller and appropriate value of PF for existing control mode.

**TABLE 6.6 DELAY ADJUSTMENT FACTOR**

Controller-type Adjustment Factor (CF)		
Controller Type	Non-coordinated intersections	Coordinated Intersections
<b>Pretimed (No traffic-actuated lane groups)</b>	1.0	PF as computed using equation (6.17)
<b>Semi-Actuated:</b>		
• Traffic-actuated lane groups	0.85	1.0
• Non-Actuated lane groups	0.85	PF as computed using equation (6.17)
<b>Fully Actuated (All lane groups actuated)</b>	0.85	Treat as semi-actuated

Source: US HCM 1994



Adjustment factor for Quality or Progression Adjustment Factor, PF applies to all coordinated lane groups, including pre-timed control and non-actuated lane groups in semi actuated control systems. A good signal progression will give a high proportion of vehicles arriving on the green, whereas poor signal indicates a low percentage of vehicles arriving on the green.

$$\text{Progression Adjustment Factor, } PF = \frac{(1-P)f_p}{1-\frac{g}{C}}$$

Eq 6.17

Where:

- $P$  = proportion of vehicles arriving on the green
- $\frac{g}{C}$  = proportion of available green time
- $f_p$  = supplemental adjustment factor for when the platoon arrives during green

The default values for  $f_p$ ,  $g/C$  ratio and Arrival Type factor are shown in **TABLE 6.7**. Also shown are  $R_p$  and Incremental Delay calibration term,  $m$ .

**TABLE 6.7: PROGRESSION ADJUSTMENT FACTOR**

Green Ratio (g/C)	Arrival Type (AT)					
	AT-1	AT-2	AT-3	AT-4	AT-5	AT-6
0.20	1.167	1.007	1.000	1.000	0.833	0.750
0.30	1.286	1.063	1.000	0.986	0.714	0.571
0.40	1.445	1.136	1.000	0.895	0.555	0.333
0.50	1.667	1.240	1.000	0.767	0.333	0.000
0.60	2.001	1.395	1.000	0.576	0.000	0.000
0.70	2.556	1.653	1.000	0.256	0.000	0.000
Default, $f_p$	1.00	0.93	1.00	1.15	1.00	1.00
Default, $R_p$	0.333	0.667	1	1.333	1.667	2

- Note:
- 1 - Tabulation based on default values of  $f_p$  and  $R_p$
  - 2 -  $P = R_p g/C$  may not exceed 1.0
  - 3 -  $PF$  may not exceed 1.0 for AT-3 through AT-6

The value of  $P$  can be measured at the site or estimated from the arrival type. Arrival type can be divided into 6 types as adapted from the HCM 2000.

- (a) Arrival Type 1 (AT-1)  
Dense platoon, containing over 80 percent of the lane group volume, arriving at the start of the red phase. This AT is representative of network links that may experience very poor progression quality as a result of conditions such as overall network signal optimization.
- (b) Arrival Type 2 (AT-2)  
Moderately dense platoon arriving in the middle of the red phase or dispersed platoon, containing 40 to 80 percent of the lane group volume, arriving throughout the red phase. This AT is representative of unfavorable progression on two-way arterials.
- (c) Arrival Type 3 (AT-3)  
Random arrivals in which the main platoon contains less than 40 percent of the lane group volume. This AT is representative of operations at isolated and non-interconnected signalized intersection characterized by highly dispersed platoons. It may also be used to represent coordinated operation in which the benefits of progression are minimal.
- (d) Arrival Type 4 (AT-4)  
Moderately dense platoon arriving in the middle of the green phase or dispersed platoon, containing 40 to 80 percent of the lane group volume, arriving throughout the green phase. This AT is representative of favourable progression quality on a two- way arterial.
- (e) Arrival Type 5 (AT-5)  
Dense to moderately dense platoon, containing over 80 percent of the lane group volume, arriving at the start of the green phase. This AT is representative of highly favourable progression quality, which may occur on routes with low to moderate side- street entries and which receive high-priority treatment in the signal-timing plan design.
- (f) Arrival Type 6 (AT-6)  
This arrival type is reserved for exceptional progression quality on routes with near- ideal progression characteristics. It is representative of very dense platoons progressing over a number of closely spaced intersections with minimal or negligible side-street entries.

Arrival Type 4 usually is used as the base condition for coordinated lane groups when planning for future

situations involving coordination. For all uncoordinated lane groups, Arrival Type 3 should be used in the calculation.

#### 6.2.15.3 Incremental Delay, $d_2$

Equation below describes the delay based on non-uniform arrivals and individual cycle failures. The equation can only be used for values of  $X$  less than 1.0 but may be used with some caution for values of  $X$  not more than 1.2, usual upper limit of delay model, or 1/PHF. In cases where  $X = 1.0$ , the delay estimate applies to all vehicles arriving during the first 15-minutes period during which oversaturation usually do happen. The equation does not take into consideration for the cumulative effect of queues remaining from a previous 15-minutes period. This equation will be invalid if the value of  $X$  exceeds 1/PHF because the hourly volume exceeds the hourly capacity.

$$d_2 = 900T \left\{ (X - 1) + \sqrt{[(X - 1)^2 + 8klX / cT]} \right\} \quad \text{Eq 6.18}$$

where

- $T$  = duration of analysis period
- $k$  = incremental delay factor that is dependent on controller settings
- $l$  = upstream filtering / metering adjustment factor
- $X$  = v/c ratio for lane group
- $c$  = capacity of lane group (vph)

#### 6.2.15.4 Incremental Delay Calibration factor, $k$

The calibration term ( $k$ ) is included in Equation 6.18 in section 6.2.8.3 to incorporate the effect of controller type on delay.

For pre-timed signal,  $k = 0.50$ . The value is based on a queuing process with random arrivals and uniform service time equivalent to the lane group capacity. In contrast, actuated controllers have the ability to modify the green time to traffic demand. As a result, it will reduce the value of incremental delay. The recommended  $k$ -values for pretimed and actuated lane groups are given in **TABLE 6.8**.

**TABLE 6.8: k-VALUES TO ACCOUNT FOR CONTROLLER TYPE**

Unit Extension (s)	Degree of Saturation (X)					
	≤0.50	0.60	0.70	0.80	0.90	≥1.0
≤2.0	0.04	0.13	0.22	0.32	0.41	0.50
2.5	0.08	0.16	0.25	0.33	0.42	0.50
3.0	0.11	0.19	0.27	0.34	0.42	0.50
3.5	0.13	0.20	0.28	0.35	0.43	0.50
4.0	0.15	0.22	0.29	0.36	0.43	0.50
4.5	0.19	0.25	0.31	0.38	0.44	0.50
5.0 <sup>a</sup>	0.23	0.28	0.34	0.39	0.45	0.50
Pretimed or nonactuated movement	0.50	0.50	0.50	0.50	0.50	0.50

**Note:**  
 For a given unit extension and its  $k_{min}$  value at  $X = 0.5$ :  $k=1(1-2k_{min})(X-0.5) + k_{min}$ ,  $k \geq k_{min}$ , and  $k \leq 0.5$ .  
 a. For unit extension > 5.0, extrapolate to find k, keeping  $k \leq 0.5$ .

Source HCM 2010

#### 6.2.15.5 Initial Queue Delay, $d_3$

When a residual queue from a previous time period causes an initial queue to occur at the start of the analysis period (T), additional delay is experienced by vehicles arriving in the period since the initial queue must first clear the intersection (TRB, 2000). The estimation of initial queue delay can be done by using

$$d_3 = \frac{1800 Q_b (1 + u) t}{cT} \quad \text{Eq 6.19}$$

Where:

- $Q_b$  = initial queue at the start of period T (veh)
- $c$  = adjusted lane group capacity (veh/hr)
- $T$  = analysis period (hr)
- $t$  = duration of unmet demand in T (hr)
- $u$  = delay parameter

$d_3$  can be assumed as 0 if residual queue from the previous phase is negligible.

#### 6.2.15.6 Approach Delay, $d_A$

The delay for an approach is computed using the Approach Delay equation below. It is desirable to aggregate these values to provide delay for an intersection approach and for the intersection as a whole. This aggregation is done by computing weighted averages, where the lane group delays are weighted by the adjusted flows in the lane groups.

$$\text{Approach Delay, } d_A = \frac{\sum d_i v_i}{\sum v_i} \quad \text{Eq 6.20}$$

Where:

- $d_A$  = delay for approach A (sec/veh)
- $d_i$  = delay for lane group i (on approach A)(sec/veh)
- $v_i$  = adjusted flow for lane group i (veh/hr)

Average delay per vehicle for the intersection is computed using the following equation

$$\text{Intersection Delay, } d_I = \frac{\sum d_A v_A}{\sum v_A} \quad \text{Eq 6.21}$$

Where:

- $d_I$  = average delay per vehicle for the intersection (sec/veh)
- $v_A$  = adjusted flow for approach A (veh/hr)

The LOS of the intersection is then determined based on the Intersection Delay,  $d_I$  value against the delay segments tabulated in Table 6.5.

#### 6.2.16 Guiding Principles

Some guiding principles to be used in accomplishing the objective of this chapter are as follows: -

- (a) The number of phases should be kept to a minimum; each additional phase reduces the effective green time available for the movement of traffic flows. (Increases lost time due to starting delays and clearance intervals or intergreen intervals).
- (b) Short cycle lengths yield the best performance in terms of providing the lowest average delay, provided the capacity of the cycle to pass vehicles is not exceeded.

- (i) For two-phase operations, short cycle lengths (40 to 60 seconds) are generally recommended to produce minimum delay.
  - (ii) Cycle lengths over 60 seconds will accommodate more vehicles per hour if there is a constant demand during the entire green period of each approach. (Longer cycle lengths have a higher capacity since over a given time period, there is a lower frequency of starting delays and clearance intervals.
  - (iii) A 180 second cycle length is recommended to be the maximum cycle length used, however longer cycle lengths can be considered if the longer cycle lengths are found to increase the junction capacity without significantly increasing total delay.
- (c) The level of service of the signalized intersection must be the same as the level of service of the road system at that location. See Table 6.5 (Level of service for Signalized Intersection) and Table 6.9 (Level of Service of Road)

**TABLE 6.9 LEVEL OF SERVICE OF ROAD**

<b>AREAS</b>	<b>CATEGORY OF ROAD</b>	<b>LEVEL OF SERVICE</b>
<b>Rural</b>	Expressway	C
	Highway	C
	Primary	D
	Secondary	D
	Minor	E
<b>Urban</b>	Expressway	C
	Arterial	D
	Collector	D
	Local Street	E

- (d) For an existing signalised junction, there should be at least two peak hour timing (morning and evening peak hour) and one non-peak hour timing to be provided in order to ensure the efficiency of the junction at different time of the day.
- (e) The traffic data used to analyse the junction shall be reviewed whenever necessary.

## CHAPTER 7: DESIGN OF COORDINATED SIGNAL TIMING

### 7.1 Introduction

A coordinated signal system is defined as having two or more individual signalised intersections which are linked together for coordination purposes. To obtain system coordination, all signals must operate with the same (common) cycle length, although in rare instances some intersections within the system may operate at double or one-half the cycle length of the system. Although at individual intersections, the intervals (red, green, and yellow) may vary according to traffic conditions, it is desirable that the arterial for which coordination is being provided have a green plus yellow interval equivalent to at least 50% of the cycle length.

The justification to coordinate intersections is easiest when the intersections are in close proximity and when the through volumes between adjacent junctions are large. Site observations can also be utilized to identify the need for coordination. If traffic arriving at the downstream junction is in the form of platoons formed by the release of vehicles from an upstream intersection, it may be beneficial to implement coordination. If the vehicle arrival pattern is random and unrelated to the operations of the upstream intersection, then coordination may not provide significant operational benefits. The MUTCD provides the guidance that signals within 800 metres of each other along a corridor should be coordinated unless operating on different cycles lengths. At distances greater than 1.0 km, it would be necessary to review the formation of platoons in traffic flow. In both cases the local traffic conditions and community needs should also be considered as part of the decision.

### 7.2 Advantages

Some of the advantages of providing coordination among signals are:

- (a) A higher level of traffic service is provided in terms of higher overall speed and reduced number of stops.
- (b) Traffic should flow more smoothly, often with an improvement in capacity and reduction in fuel consumption, air pollution, noise, and vehicle wear and tear.
- (c) Vehicle speeds should be more uniform because there will be no incentive to travel at excessively high speed to reach a signalised intersection before the start of the green interval, yet slower drivers will be encouraged to speed up to avoid having to stop for a red light.
- (d) There should be fewer accidents because platoons of vehicles will arrive at each signal when it is green, thereby reducing the possibility of red-signal violations or rear-end collisions. Naturally, if there are fewer red intervals displayed to the majority of motorists, there is less likely to be trouble because of driver inattention, brake failure, slippery pavement, and so on.
- (e) Greater obedience to the signal commands should be obtained from both motorists and pedestrian because the motorists will try to keep within the

green interval and the pedestrian will stay at the kerb because the vehicles will be closer spaced.

- (f) Through traffic will tend to stay on the arterial road instead of on parallel minor roads.
- (g) Development of green wave where a series of traffic lights are coordinated to facilitate continuous traffic flow over several intersections in one or two main directions.
- (h) Reduces driver frustration.

There are various types of traffic signal coordinating methods. These include:

- (a) Local Interlinking – comprising of a small number of usually closely spaced signals interconnected by a cable which allows the operation of one signal to affect the operation of others. In some systems, one signal controller assumes the role of ‘master’ and may contain a number of timing plans to suit different phasing times for different times of the day.
- (b) Synchronous Linking – Wireless linking, (eg. GPS Clock, RFID, etc) and coordination of signals is achieved by reference to an accurate measurement device in each signal controller.
- (c) Wide area systems – also known as area traffic control or urban traffic control systems. The concept involves one or more centrally located computers controlling a relatively large number of signals. These systems provide centralized monitoring and control of the member signals and often include a traffic control centre.
- (d) Fixed Time Control – Uses predetermined signal timing plans which are introduced according to a timetable. Depending on the complexity and variation of traffic demand patterns, usually between three to ten plans are provided.
- (e) Traffic Responsive Control – uses vehicle detection at some or all signals to enable the system to respond to changes in traffic pattern or system capacity by way of changing the timing plan of the traffic signals. The simplest form of traffic responsive system is based on traffic pattern matching where the timing plan is modified by comparison of traffic data of traffic data measured by selected detectors located to capture traffic conditions. More complex traffic responsive systems employing a large number of detectors can also be used.

All the above traffic coordinating methods can be utilized to formulate and develop a green wave which would allow all vehicles within the wave to drive through a sequence of green signalled traffic lights at a certain speed without having to stop at the signals. The green wave can be formulated and set up to operate in one direction or both directions. Green waves can also be utilised to facilitate the movement of cyclists, emergency and public transport vehicles.



### 7.3 Applications

Traffic signal coordination is strongly influenced by various dynamic conditions such as corridor speeds, traffic signal spacing, congestion along the corridor, traffic volumes on major streets, pedestrian volumes especially crossing volumes, traffic signal cycle lengths, additional left turn phasing and safety considerations. Factors that limit the benefit of signal coordination are as follows:

- (a) Inadequate Road Capacity
- (b) Existence of substantial side frictions such as parking, loading activity, double parking and multiple driveways
- (c) Wide variability in actual individual operating speed
- (d) Very short signal spacing
- (e) Heavy turning volumes wither into or out of minor roads

In a discussion of the two-way and one-way street applications of system timing, the following terms are frequently used:

- (a) Through-band: the space between a pair of parallel speed lines which delineates a coordinated movement on a time-space chart.
- (b) Band speed: the slope of the through-band representing the progression speed of traffic moving along the arterial.
- (c) Bandwidth: the width of the through-band expressed in seconds (or percent of cycle length), indicating the period of time available for traffic to flow within the band.

#### 7.3.1 One-Way Road

The simplest form of coordinating signals is along a one-way road, or to favor one direction of traffic on a two-way road that contains highly directional traffic flows. Essentially, the mathematical relationship between the band speed  $S$  and the offset  $L$  can be described as: -

$$S = \frac{D}{0.278L} \quad \text{Eq 7.1}$$

where

- $S$  = speed of progression (km/hr)
- $D$  = spacing of signals (m)
- $L$  = offset in seconds

#### 7.3.2 Two-Way Road

For a two-way movement, four general coordinated signal systems are possible:

- (a) simultaneous,
- (b) alternate,
- (c) limited (simple) coordinated, and
- (d) flexible coordinated.

The relative efficiency of any of these systems is dependent on the distances between signalised intersections, the speed of traffic, the cycle length, the road-way capacity, and the amount of friction caused by turning vehicles, parking maneuvers, improper or illegal parking or loading, and pedestrians. In general, a two-way progression with maximum bandwidths can be achieved only if the signal spacing are such that vehicular travel times between signals are a multiple of one-half the common cycle length; otherwise, inevitable compromises have to be made in the coordinated design.

### 7.3.2.1 Simultaneous System

In a simultaneous system, all signals along a given street operate with the same cycle length and display the green indication at the same time. Under this system, all traffic moves at one time, and a short time later all traffic stops at the nearest signalised intersection to allow cross-road traffic to move.

The mathematical relationship between the band speed (in both directions) and signal spacing in a simultaneous system can be described as follows.

$$S = \frac{D}{0.278C} \quad \text{Eq 7.2}$$

where

- S = speed of progression (km/hr)
- D = spacing of signals (m)
- C = cycle length in seconds

For example, a system of signalised intersections at 0.5 km spacing could have a band speed in a simultaneous system 30 km/h, respectively, with a 60 sec cycle. With closely spaced intersections, however, a simultaneous system may encourage excessive speeds as drivers tend to travel through a maximum number of intersections during the green interval.

### 7.3.2.2 Alternate System

In the alternate system, each successive signal or group of signal shows opposite indications to that of the next signal or group. If each signal alternates with those immediately adjacent, the system is called single alternate. If pairs of signals alternate with adjacent pairs, the system is termed double alternate; and so on.

The band speed in a single-alternate system is: -

$$S = \frac{D}{0.139C} \quad \text{Eq 7.3}$$

In a double-alternate system, the band speed is determined by the same formula, with  $D$  being the distance between the midpoints of adjacent pairs. Generally speaking, the alternate system may provide excellent traffic service, depending on the distances between signals and the cycle length. Equal distances provide the best result.

#### 7.3.2.3 Limited (Simple) Coordinated System

In a simple coordinated system, a common cycle length is used and the various signal faces controlling a given road provide green indications in accordance with a time schedule to permit continuous operation of platoons along the road at a designed rate of speed, which may vary within different parts of the system.

#### 7.3.2.4 Flexible Coordinated System

In a flexible coordinated system, the signal offsets, splits, and/or cycle length of the common cycle are changed to suit the needs of traffic throughout the day. For example, an inbound progression toward the central business district during the morning peak can be changed to an outbound progression during the remainder of the day merely by adjusting the signal offsets, or a longer cycle length can be used during the morning and evening peak hours in order to provide greater capacity than during the off-peak period.

### 7.4 Coordinated Signal System Design

#### 7.4.1 Selection of A Cycle Length

In the selection of a trial cycle length, the criterion that band speeds be at or near the mean operating speed of vehicles on the street is frequently used. If the spacing in the system is fairly regular, equations (7.1) to (7.3) may be solved for  $C$  (cycle length) by using the measured operating speed for  $S$  and the typical distance between proposed signals for  $D$ . The resultant cycle lengths falling in a usable range should be compared with the cycle length computed for each individual intersection. If one cycle length approximates or slightly exceeds those computed for a majority of individual intersection it should be selected on a trial basis. First, however, each individual intersection must be reexamined to assure that it can operate effectively with the selected cycle length. Sometimes rephasing or geometric and/or operational

improvements at an intersection will be required. If such changes are not feasible, and the operation with this cycle length would seriously impaired one or more intersections, a new trial cycle length should be selected. In practice, the cycle length already established for signal systems intersection or closely adjacent to the system under study will frequently dictate the cycle length to be used.

#### **7.4.2 Design Methodology for Arterial Routes**

To develop an arterial-based timing plan, a considerable amount of data must be collected initially, including: -

- (a) Intersection spacing
- (b) Road geometrics
- (c) Traffic volumes
- (d) Traffic regulations such as parking, speed limit, and turn restrictions
- (e) Speed and delay information

Using the data, a number of timing plans are then determined together with the individual timing requirements at each signalised location. For each plan a cycle length is selected which is common to the arterial route, and a graphical analysis of the type illustrated in **FIGURE 7.1** is undertaken by a trial-and-error process to determine offsets for each of the desired timing plans.

**FIGURE 7.1** is a two-dimensional graph portraying a two-directional coordinated arterial system with distance on the horizontal scale and time on the vertical scale. The intersections are located on the distance scale with vertical reference lines drawn at the centerline of all signalised intersections. A horizontal working line is drawn across the graph on which the green or red phase of each signalised intersection at the left edge of the diagram, signal phases are constructed on the vertical reference line with either a green or red phase centered on the working line. A progression speed line which has a slope representing the desired progression speed is drawn starting at the beginning of the green phase at the first signalised intersection. For each succeeding intersection, either a red or green signal phase is centered on the horizontal working line to obtain an equal bandwidth for each direction of flow. Should coordinated movement be desired in only one direction, this procedure may be modified such that the beginning of the green phase at each intersection is placed on the progression speed line.

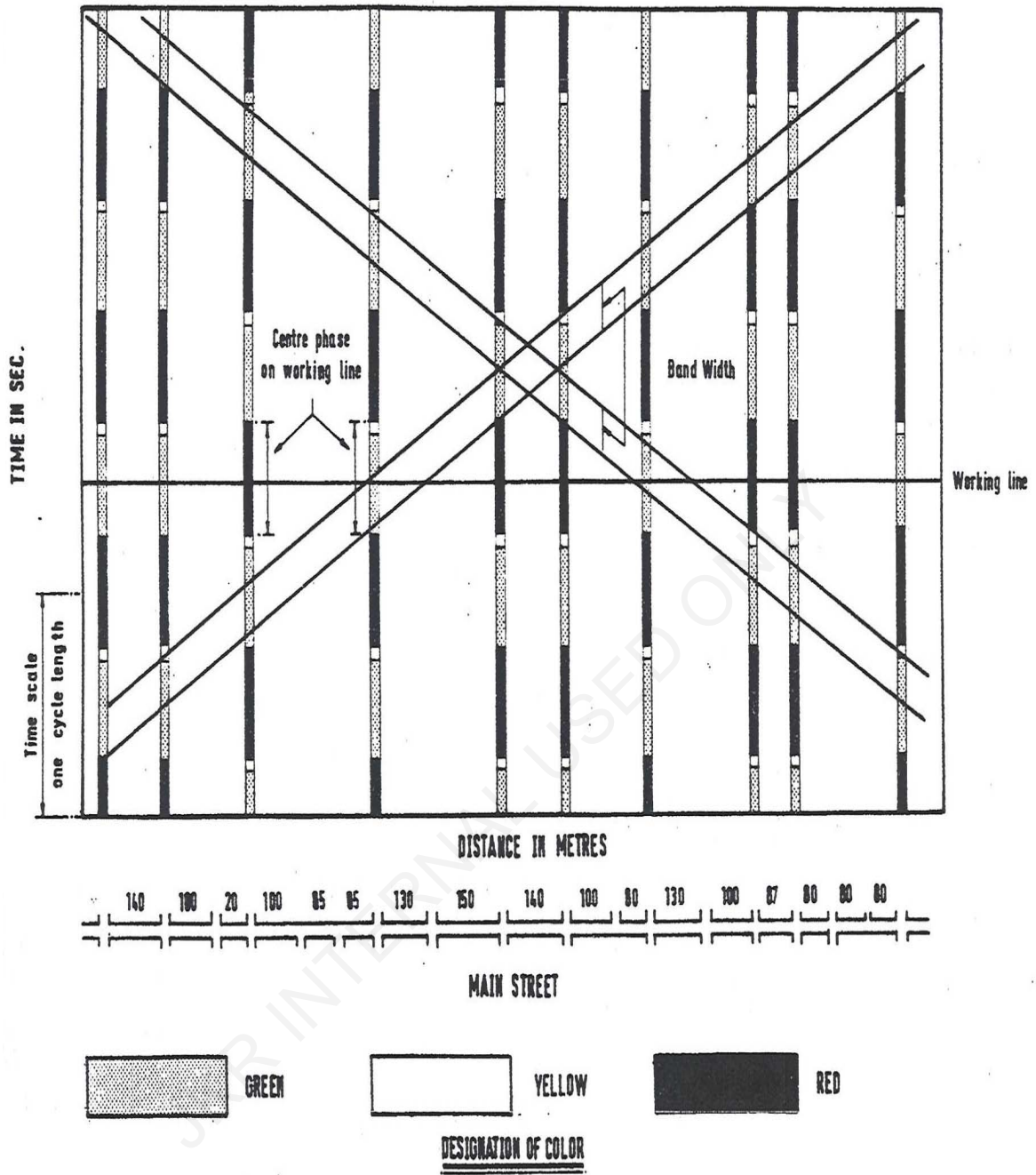


FIGURE 7.1 TYPICAL TIME SPACE DIAGRAM

## REFERENCES

1. *Jabatan Kerja Raya (JKR) Malaysia, 1987. Arahan Teknik (Jalan) 13/87, A Guide To The Design of Traffic Signals, Jabatan Kerja Raya (JKR) Malaysia, Kuala Lumpur.*
2. *Federal Highway Administration U.S. Department of Transportation, 2009. Manual on Uniform Traffic Control Devices (MUTCD), Federal Highway Administration U.S. Department of Transportation.*
3. *Highway Planning Unit Malaysia, 2006. Highway Capacity Manual, Highway Planning Unit, Ministry of Works, Malaysia.*
4. *Transportation Research Board, 2000. Highway Capacity Manual 2000, Transportation Research Board, National Research Council, US.*
5. *Transportation Research Board, 2010. Highway Capacity Manual 2010, Transportation Research Board, National Research Council, US.*
6. *BS EN 12368:2015 Traffic control equipment – Signal heads*
7. *MS 2478:2012 Traffic control equipment – Performance of signal heads*

JKR INTERNAL USE ONLY

## GLOSSARY

**Arterial Road** – Main trunk road.

**Clarity** – the message or direction given can easily understand. In other words, the signal must be seen in order for the motorist to react and the required action must be obvious.

**Cone of Vision** – the cone-shaped field of vision that extends from the motorists to the road beyond.

**Conspicuity** – that signal must not only be visible, but must be obvious to the eye and attract attention.

**Control delay** – The component of delay that results when a control signal causes a lane group to reduce speed or to stop; it is measured by comparison with the uncontrolled condition.

**Delay** – The additional travel time experienced by a driver, passenger, or pedestrian.

**Green Interval** – A pre-set minimum and maximum time limit for the green light in each cycle.

**Ideal Saturation Flow** – The saturation flow rate of a twelve-foot (3.66m), straight through only lane in non-CBD area, with level gradient, no bus blockages and no adjacent parking activities. In Malaysian road condition, a value of 1930 pcu/hr/ln is adopted.

**Incremental delay** – The second term of lane group control delay, it accounts for non uniform arrivals and temporary random delays as well as delays caused by sustained periods of oversaturation.

**Initial queue delay** – The third term of lane group control delay refers to the delay due to a residual queue identified in a previous analysis period and persisting at the start of the current analysis period. This delay results from the additional time required to clear the initial queue.

**Inter-green period** – The period of time between the termination or the green signal for one phase and the beginning of the green signal for the next phase to receive the right of way.

**Interval** – A discrete portion of the signal cycle during which the signal indications remain unchanged.

**Interval Timing** – The passage of time which occurs during an interval.

**Loop Detector** – A device capable of sensing a change in inductance of a loop sensor imbedded in the roadway caused by the passage or presence of a vehicle over the loop.

**Maximum acceptable cone** – the motorist's vision is "adequate" at 20° to the left and 20° to the right of the "center of the approach lanes extended" (cone of 40°).

**Maximum green** – The maximum (preset) period of a green signal can last after a demand has been made by traffic on another phase.

**Maximum Time Gap** – The "density" function of the signal which will decrease as the green phase continues. The green phase ends when the maximum gap is exceeded, or when the maximum length of phase is reached, whichever comes first.

**Minimum green** – The shortest period of time a green signal may be displayed during any phase.

**Minimum visibility** – the distance from the stop line at which a signal should be continuously visible for various approach speeds.

**Occupancy** – The percentage of roadway occupied by vehicles at an instant in time. In general use, it is a measurement based upon the ratio of vehicle presence time (as indicated by a presence detector) over a fixed period of total time.

**Offset** – The time difference or interval in seconds between the start of the green indication at one intersection as related to the start of the green interval at another intersection or from a system time base.

**Parameter** – (1) A quantity in mathematics that may be assigned any arbitrary value and that remains constant during some calculation;

(2) A definable characteristics of an item, device, or system.

**Pattern** – A unique set of traffic parameters (cycle, split, and offset) associated with each signalized intersection within a predefined group of intersection (a section or subzone)

**Phase** – A part of the traffic signal time cycle allocated to any combination of traffic movements receiving right of way simultaneously during one or more intervals.

**Plan** – A plan gives the relationship between phases and signal groups in terms of time. The possibilities of a plan can be laid down in a time cycle diagram of one or more intersection control units.

**Recall** – An operational mode for an actuated intersection controller whereby a phase, either vehicle or pedestrian is displayed each cycle whether demand exists or not. Usually a temporary emergency situation.

**Relay** – An electromagnetic switching device, having multiple electrical contacts, energised by electrical current through its coil. It is used to completed electrical circuits.



**Saturation flow** – The maximum flow that can pass through an intersection approach under prevailing traffic and roadway conditions, assuming that the approach had 100% of real time available as effective green time.

**Short (Single Lane) Loop Detector** – Use to detect a vehicle upstream of the stop line (usually up to 6 meter in length for 1 loop).

**Signal group** – A set of one or more signal indications which are switched on an off simultaneously.

**Signal Head** – An assembly containing one or more signal faces that may be designated accordingly as one-way, two-way, etc.

**Signal Indication** – The following of a traffic signal lens or equivalent device or a combination of several lenses or equivalent devices at the same time.

**Signal face** – That part of a signal head that contains lenses and associated components (such as bulbs, reflectors, visors) provided for controlling traffic in a single direction. Turning indications may be included in a signal face.

**Split** – A percentage of the cycle length allocated to each of the various phases in a signal sequence.

**Stops** – The number of times vehicles stop in the system. Used as a measure of effectiveness to assess the effectiveness of a timing pattern. A computer-controlled system goal is to minimize stops.

**Traffic** – Vehicles, persons or animals, travelling on a highway considered collectively.

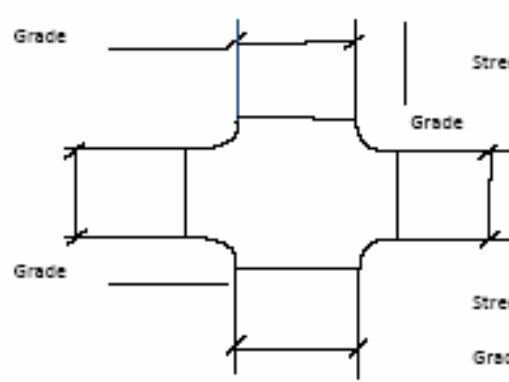








**Uniform delay** – The first term of the equation for lane group control, assuming uniform arrivals.



**APPENDIX A  
WORKSHEET**

1. INPUT WORKSHEET
2. VOLUME ADJUSTMENT AND SATURATION FLOW RATE WORKSHEET
3. CAPACITY AND LOS WORKSHEET

# 1. INPUT WORKSHEET

INPUT WORKSHEET												
General Information						Site Information						
Analyst	_____					Intersection	_____					
Agency or Company	_____					Area type	_____ CBD		_____ OTHER			
Date Performed	_____					Jurisdiction	_____					
Analysis Time Period	_____					Analysis Year	_____					
Intersection Geometry												
Grade _____						 Show North Arrow	Pedestrian button Lane width Through Right Left Through + Right Through+ Left Left+Right Left + Through + Right					
						Street _____						
						Grade _____						
Volume and Timing Input												
	EB			WB			NB			SB		
	LT	TH	RT	LT	TH	RT	LT	TH	RT	LT	TH	RT
Lane Width												
Gradient												
Volume and Timing Input												
	EB			WB			NB			SB		
	LT	TH	RT	LT	TH	RT	LT	TH	RT	LT	TH	RT
Volume, V (veh/h)												
Lane Group												
<b>Total Cars</b>												
% Total Cars												
<b>Total Motors</b>												
% Total Motors												
<b>Total Trailers</b>												
% Total Trailers												
<b>Total Lorries</b>												
% Total Lorries												
<b>Total Busses</b>												
% Total Busses												
Peak-Hour factor, PHF												
Pretimed (P) or actuated (A)												
Start-up lost time, l, (s)												
Extension of effective green time, e(s)												
Arrival type, AT												
Parking (Y or N)												
Parking maneuvers, N <sub>pm</sub> (maneuvers/h)												
Bus stopping, N <sub>b</sub> (buses/h)												
Signal Phasing Plan												
	1	2	3	4	5	6	7	8				
DIAGRAM												
Timing	G = I =	G = I =	G = I =	G = I =	G = I =	G = I =	G = I =	G = I =				
	 Protected turn		 Permitted turns  Pedestrian				Cycle length, C= _____ s					

## 2. VOLUME ADJUSTMENT AND SATURATION FLOW RATE WORKSHEET

VOLUME ADJUSTMENT AND SATURATION FLOW RATE WORKSHEET												
General Information												
Project Description												
Volume Adjustment												
	EB			WB			NB			SB		
	LT	TH	RT	LT	TH	RT	LT	TH	RT	LT	TH	RT
Volume, V (veh/h)												
Peak-Hour factor, PHF												
Adjusted flow rate in lane group, $v_p$ (veh/h)	(Eq 6.1)											
Vehicle Composition Factor												
	EB			WB			NB			SB		
	LT	TH	RT	LT	TH	RT	LT	TH	RT	LT	TH	RT
Lane Group	L	T	R	L	T	R	L	TR		L	TR	
$f_{car}$												
$f_{motor}$												
$f_{trailer}$												
$f_{lorry}$												
$f_{bus}$												
Proportion <sup>1</sup> of LT or RT (P <sub>LT</sub> or P <sub>RT</sub> )												
Saturation Flow Rate												
Base saturation flow, $S_0$ (pc/h/ln)	1930	1930	1930	1930	1930	1930	1930	1930	1930	1930	1930	1930
Number of lanes, N	1	1	1	1	1	1	1	1	1	1	1	1
Lane width adjustment factor, $f_w$	(Eq 6.3)											
Vehicle composition adjustment factor, $f_c$	(Eq 6.6)											
Grade adjustment factor, $f_g$	(Eq 6.4 or 6.5)											
Area type adjustment factor, $f_a$	(Table 6.1)											
Left turn adjustment factor, $f_{lt}$	(Table 6.2)											
Right turn adjustment factor, $f_{rt}$	(Table 6.3)											
Adjusted saturation flow, S (veh/h), $S = S_0$ ,												
$S = S_0 \times N \times f_w \times f_g \times f_a \times f_{lt} \times f_{rt} \times (1/f_c)$	(Eq 6.2)											
Noted												
1. P <sub>LT</sub> = 1.000 for exclusive left turn lanes, and P <sub>RT</sub> = 1.000 for exclusive right turn lanes. Otherwise, they are equal to the proportions of turning volumes in the lane group												

### 3. CAPACITY AND LOS WORKSHEET

CAPACITY AND LOS WORKSHEET												
General Information												
Project Description												
Capacity Analysis												
Phase number												
	EB			WB			NB			SB		
Lane group	L	T	R	L	T	R	L	TR	R	L	TR	R
Adjusted flow rate, $v_p$ (veh/h)												
Saturation flow rate, $s$ (veh/h)												
Lost time, $t_l$ (s) = $l_1 + Y \cdot e$ (Eq. 6.8)												
Effective green time, $g(s)$ , $g = G + Y \cdot t_l$ (Eq. 6.9)												
Green ratio, $g/C$ (Eq. 6.10)												
Lane capacity, $c = s(g/C)$ , (veh/h) (Eq. 6.11)												
$v_p/c$ ratio, $X$ (Eq. 6.12)												
Flow ratio, $\gamma = v_p/s$ (Eq. 6.13)												
Critical lane group/phase (v)												
Sum of flow ratios for critical lane groups, $\gamma_c$												
$\gamma_c = \sum$ (critical lane group, v/s)												
Total lost time per cycle, $L$ (s)												
Critical flow rate to capacity ratio, $X_c$												
$X_c = (\gamma_c)/(C-L)$												
Lane Capacity, Control Delay and LOS Determination												
	EB			WB			NB			SB		
	LT	TH	RT	LT	TH	RT	LT	TH	RT	LT	TH	RT
Adjusted flow rate, $^2v_p$ (veh/h)												
Lane group capacity, $^2c$ (veh/h)												
$v_p/c$ ratio, $^2X = v_p/c$												
Total green ratio, $^2g/C$												
Uniform delay, $d_1$ (sec/veh) $d_1 = 0.5C [1 - g/C]^2 / [1 - (g/C) \text{Min}(1, X)]$ (Eq. 6.16)												
Incremental delay calibration, $^3k$												
Incremental delay, $d_2$ (sec/veh) $d_2 = 900T \{ (X-1) + \sqrt{(X-1)^2 + 8kIX/cT} \}$ (Eq. 6.18)												
Initial queue delay, $d_3$ (sec/veh) (Eq. 6.19)												
Uniform delay, $d_1$ (s/veh) (Eq. 6.16)												
Progression adjustment factor, PF (Table 6.6 or Eq. 6.17)												
Delay, $d = d_1(PF) + d_2 + d_3$ (s/veh) (Eq. 6.15)												
LOS by lane group (Table 6.5)												
Delay by approach, $d_A$ (sec/veh) $d_A = (\sum [d_i v_i])$ (Eq. 6.20)												
LOS by approach (Table 6.5)												
Approach flow rate, $v_A$ (veh/h) (Table 6.5)												
Intersection delay, $d_I$ (sec/veh) $d_I = (\sum [d_A v_A])$ (Eq. 6.21)												
<b>Notes</b> 1. For permitted left turns, the minimum capacity is $(1+PL)(3600/C)$ 2. Primary and second to the proportions of turning volumes in the lane group 3. For permitted or nonactuated signals, $k = 0.50$ 4. T=analysis duration (h); typically T= 0.25 which is for the analysis duration of 15 minutes l=upstream filtering metering adjustment factor, l=1 isolated intersections.												

**APPENDIX B**  
**STEPS CALCULATION OF EXAMPLE**

JKR INTERNAL USE ONLY

EXAMPLE PROBLEM 1

**The Intersection** The intersection is located in the central business district (CBD) of a small urban area. The main street is EB/WB while NB/SB is minor road. Intersection geometry and flow characteristics are shown in the Input Worksheet.

**The Question** What are the delay and peak-hour LOS of this intersection?

**The Facts**

- √ EB and WB has three lanes, one in each direction,
- √ NB and SB HV has two lanes where through and right turn is shared,
- √ No parking at intersection,
- √ Four-phase signal
- √ Level terrain

**Comments**

- √ Assume base saturation flow rate = 1,930 pc/h/ln,
- √ 162s cycle length, with green times given

INTERSECTION STEP CALCULATION		
<b>Volume Adjustment</b>		
1. Adjusted flow rate in lane group, $v_p$ (veh/h)	$v_p = \frac{V}{PHF}$ $v_p = \frac{12}{0.89}$ $v_p = 13 \text{ veh/h}$	Eq 6.1
<b>Saturation Flow Rate</b>		
2. Base saturation flow, $S_o$ (pc/h/ln)	$S_o = 1930 \text{ pc/h/ln}$	
3. Number of lanes, N	1	
4. Lane width adjustment factor, $f_w$	$f_w = 1 + \frac{w - 3.66}{3.663}$ $f_w = 1 + \frac{3.92 - 3.66}{3.663}$ $f_w = 1.07$	Eq 6.3
5. Vehicle composition adjustment factor, $f_c$	$f_c = f_{car} + f_{trailer} + f_{bus} + f_{lorry} + f_{motor}$ $f_c = 0.333 + 0.378 + 0 + 0.397 + 0.403$ $f_c = 1.512$	Eq 6.6
6. Grade adjustment factor, $f_g$	$f_g = 1$	Eq 6.4 or 6.5
7. Area type adjustment factor, $f_a$	$f_a = 1$	Table 6.1
8. Left turn adjustment factor, $f_{LT}$	$f_{LT} = 0.76$	Table 6.2
9. Right turn adjustment factor, $f_{RT}$	$f_{RT} = 1$	Table 6.3



10. Adjusted saturation flow, S (veh/h)	$S = S_o \times N \times f_w \times f_g \times f_a \times f_{LT} \times f_{RT} \times (1/f_c)$ $S = 1930 \times 1 \times 1.07 \times 1 \times 1 \times 1 \times 0.76 \times 1 \times 1/1.512$ $S = 1038 \text{ veh/h}$	Eq 6.2
<b>Capacity Analysis</b>		
11. Adjusted flow rate, $v_p$ (veh/h)	$v_p = 13 \text{ veh/h}$	From Bil.1
12. Saturation flow rate, s (veh/h)	$S = 1038 \text{ veh/h}$	From Bil.10
13. Lost time, $t_L$ (s)	$t_L (s) = I_1 + I - e$ $t_L (s) = 2 + 5 - 2$ $t_L (s) = 5 \text{ s}$	Eq 6.8
14. Effective green time, g (s)	$g = G + I - t_L$ $g = 45 + 5 - 5$ $g = 45$	Eq 6.9
15. Green ratio, g/C	$C = 162 \text{ (Cycle length)}$ $g/C = 45/162$ $g/C = 0.28$	Eq 6.10
16. Lane capacity, $^1 c$ (veh/h)	$c = s (g/C)$ $c = s (g/C)$ $c = 1038 \times 0.28$ $c = 288 \text{ veh/h}$	Eq 6.11
17. $v_p/c$ ratio, X	$X = v_p/c$ $X = 13/288$ $X = 0.05$	Eq 6.12
18. Flow ratio = $v_p/s$	$\text{Flow ratio} = v_p/s$ $\text{Flow ratio} = 13/1038$ $\text{Flow ratio} = 0.01$	Eq 6.13
<b>Lane Capacity, Control Delay and LOS Determination</b>		
19. Adjusted flow rate, $^2 v_p$ (veh/h)	$v_p = 13 \text{ veh/h}$	From Bil.1

20. Lane group capacity, <sup>2</sup> c (veh/h)	c = 288 veh/h	From Bil.16
21. v <sub>p</sub> /c ratio, <sup>2</sup> X	X = 0.05	From Bil.17
22. Total green ratio, <sup>2</sup> g/C	g/C = 0.28	From Bil.15
23. Uniform delay, d <sub>1</sub> (sec/veh)	$d_1 = 0.5C \frac{[1 - \frac{g}{C}]^2}{[1 - (\frac{g}{C})] [M_{sm}(1, X)]}$ $d_1 = 0.5(162) \frac{[1 - (0.28)]^2}{[1 - (0.28)] [M_{sm}(1, 0.05)]}$ $d_1 = 42.8 \text{ sec/veh}$	Eq. 6.16
24. Incremental delay calibration, <sup>3</sup> k	k = 0.50	Table 6.8
25. Incremental delay, d <sub>2</sub> (sec/veh)	$d_2 = 900T \left\{ (X - 1) + \sqrt{(X - 1)^2 + \frac{8kIX}{cT}} \right\}$ $d_2 = 900(0.25) \left\{ (0.05 - 1) + \sqrt{(0.05 - 1)^2 + \frac{8(0.50)(1)(0.05)}{(288)(0.28)}} \right\}$ $d_2 = 0.3 \text{ sec/veh}$	Eq 6.18
26. Initial queue delay, d <sub>3</sub> (sec/veh)	$d_3 = \frac{1800 Q_0(1 + u)t}{cT}$ $d_3 = 0$	Eq. 6.19
27. Progression adjustment factor, PF		Table 6.6 or Eq. 6.17

28. Delay, d	$d = d_1 (PF) + d_2 + d_3 (s/veh)$ = 43.1 sec/veh	Eq. 6.15
29. LOS by lane group	D	Table 6.5
30. Delay by approach, $d_A$ (sec/veh)	$d_A = (\sum [d_{iv_i}])$ = 64.1 sec/veh	Eq. 6.20
31. LOS by approach	E	Table 6.5
32. Approach flow rate, $v_A$ (veh/h)	661	Table 6.5
33. Intersection delay, $d_i$ (sec/veh)	$d_i = (\sum [d_{Av_A}])$ = 54.3 sec/veh	Eq. 6.21
34. Intersection LOS	D	Table 6.5



**APPENDIX C  
EXAMPLE**

JKR INTERNAL USE ONLY

# 1. INPUT WORKSHEET

INPUT WORKSHEET															
General Information						Site Information									
Analyst _____ Agency or Company _____ Date Performed _____ Analysis Time Period _____						Intersection _____ Area type <input type="checkbox"/> CBD <input type="checkbox"/> OTHER Jurisdiction _____ Analysis Year _____									
Intersection Geometry															
						 Show North Arrow			Pedestrian button Lane width 						
Volume and Timing Input															
				EB			WB			NB			SB		
				LT	TH	RT	LT	TH	RT	LT	TH	RT	LT	TH	RT
Lane Width				3.92	3.51	3.51	3.70	3.51	3.29	3.51	3.29		2.71	2.49	
Gradient				0	0	0	0	0	0	0	0		0	0	
Volume and Timing Input															
				EB			WB			NB			SB		
				LT	TH	RT	LT	TH	RT	LT	TH	RT	LT	TH	RT
Volume, V (veh/h)				12	269	307	85	165	170	46	112	53	38	149	43
Lane Group				L	T	R	L	T	R	L	L	Tr			
<b>Total Cars</b>				4	79	166	51	71	93	20	88		11	88	
% Total Cars				33	29	54	60	43	55	43	79		29	59	
<b>Total Motors</b>				22	26	23	5	13	10	4	14		5	22	
% Total Motors				183	10	7	6	8	6	9	13		13	15	
<b>Total Trailers</b>				2	102	14	9	25	7	2	5		2	2	
% Total Trailers				17	38	5	11	15	4	4	4		5	1	
<b>Total Lorries</b>				4	56	24	6	16	19	2	12		4	5	
% Total Lorries				33	21	8	7	10	11	4	11		11	3	
<b>Total Busses</b>				0	15	6	2	25	23	8	6		4	2	
% Total Busses				0	72	77	28	258	206	184	56		38	60	
Peak-Hour factor, PHF				0.89	0.89	0.89	0.8	0.8	0.8	0.84	0.84	0.84	0.75	0.75	0.75
Pretimed (P) or actuated (A)				P	P	P	P	P	P	P	P	P	P	P	P
Start-up lost time, $l_s$ (s)				2	2	2	2	2	2	2	2	2	2	2	2
Extension of effective green time, $e$ (s)				2	2	2	2	2	2	2	2	2	2	2	2
Arrival type, AT				3	3	3	3	3	3	3	3	3	3	3	3
Parking (Y or N)				N	N	N	N	N	N	N	N	N	N	N	N
Parking maneuvers, $N_{pm}$ (maneuvers/h)				0	0	0	0	0	0	0	0	0	0	0	0
Bus stopping, $N_b$ (buses/h)				0	0	0	0	0	0	0	0	0	0	0	0
Signal Phasing Plan															
DIAGRAM	1	2	3	4	5	6	7	8							
Timing	G = 45.0 I = 3.0	G = 30.0 I = 5.0	G = 22.0 I = 5.0	G = 45.0 I = 3.0	G = I =	G = I =	G = I =	G = I =							
			-----> Permitted turns ----- Pedestrian				Cycle length, C = <u>162</u> s								

## 2. VOLUME ADJUSTMENT AND SATURATION FLOW RATE WORKSHEET

VOLUME ADJUSTMENT AND SATURATION FLOW RATE WORKSHEET												
General Information												
Project Description												
Volume Adjustment												
	EB			WB			NB			SB		
	LT	TH	RT	LT	TH	RT	LT	TH	RT	LT	TH	RT
Volume, V (veh/h)	12	269	307	85	165	170	46	112	53	38	149	43
Peak-Hour factor, PHF	0.89	0.89	0.89	0.80	0.80	0.80	0.84	0.84	0.84	0.75	0.75	0.75
Adjusted flow rate in lane group, $v_p$ (veh/h)	(Eq 6.1)											
	13	302	345	106	206	213	55	133	63	51	199	57
Vehicle Composition Factor												
	EB			WB			NB			SB		
	LT	TH	RT	LT	TH	RT	LT	TH	RT	LT	TH	RT
Lane Group	L	T	R	L	T	R	L	TR		L	TR	
$f_{car}$	0.333	0.294	0.541	0.6	0.43	0.547	0.435	0.786		0.289	0.591	
$f_{motor}$	0.403	0.021	0.016	0.013	0.017	0.013	0.019	0.028		0.029	0.032	
$f_{trailer}$	0.378	0.861	0.104	0.24	0.344	0.093	0.099	0.101		0.119	0.03	
$f_{lorry}$	0.397	0.248	0.093	0.084	0.115	0.133	0.052	0.128		0.125	0.04	
$f_{bus}$	0	0.116	0.041	0.049	0.315	0.281	0.362	0.111		0.219	0.028	
Proportion <sup>1</sup> of LT or RT (P <sub>LT</sub> or P <sub>RT</sub> )	1		1	1		1	1	0.32		1	0.22	
Saturation Flow Rate												
Base saturation flow, $S_0$ (pc/h/ln)	1930	1930	1930	1930	1930	1930	1930	1930	1930	1930	1930	
Number of lanes, N	1	1	1	1	1	1	1	1		1	1	
Lane width adjustment factor, $f_w$	(Eq 6.3)											
	1.07	0.96	0.96	1.01	0.96	0.90	0.96	0.90		0.74	0.68	
Vehicle composition adjustment factor, $f_c$	(Eq 6.6)											
	1.512	1.423	0.754	0.937	0.907	0.786	0.604	1.042		0.563	0.693	
Grade adjustment factor, $f_g$	(Eq 6.4 or 6.5)											
	1.00	1.00	1.00	1.00	1.00	1.00	1.00	1.00		1.00	1.00	
Area type adjustment factor, $f_a$	(Table 6.1)											
	1.00	1.00	1.00	1.00	1.00	1.00	1.00	1.00		1.00	1.00	
Left turn adjustment factor, $f_{LT}$	(Table 6.2)											
	0.76	1.00	1.00	0.76	1.00	1.00	0.76	1.00		0.76	1.00	
Right turn adjustment factor, $f_{RT}$	(Table 6.3)											
	1.00	1.00	0.84	1.00	1.00	0.84	0.94	1.00		0.96	1.00	
Adjusted saturation flow, S (veh/h), $S = S_0 \cdot$	(Eq 6.2)											
$S = S_0 \times N \times f_w \times f_g \times f_a \times f_{LT} \times f_{RT} \times (1/f_c)$	1038	1301	2065	1581	2043	1855	2190	1667		1851	1893	
Noted												
1. P <sub>LT</sub> = 1.000 for exclusive left turn lanes, and P <sub>RT</sub> = 1.000 for exclusive right turn lanes. Otherwise, they are equal to the proportions of turning volumes in the lane group												

### 3. CAPACITY AND LOS WORKSHEET

CAPACITY AND LOS WORKSHEET												
General Information												
Project Description												
Capacity Analysis												
Phase number	EB			WB			NB			SB		
Lane group	L	T	R	L	T	R	L	TR	R	L	TR	R
Adjusted flow rate, $v_p$ (veh/h)	13	302	345	106	206	213	55	133	63	51	199	57
Saturation flow rate, $s$ (veh/h)	1038	1301	2065	1581	2043	1855	2190	1667		1851	1893	
Lost time, $t_L$ (s) = $l_1 + V \cdot e$ (Eq. 6.8)	5	5	5	5	5	5	5	5		5	5	5
Effective green time, $g(s)$ , $g = G + V \cdot t_L$ (Eq. 6.9)	45	45	45	30	30	30	22	22		45	45	45
Green ratio, $g/C$ (Eq. 6.10)	0.278	0.278	0.278	0.185	0.185	0.185	0.136	0.136		0.278	0.278	0.278
Lane capacity, $^1c = s(g/C)$ , (veh/h) (Eq. 6.11)	288.4	361.5	573.5	292.7	378.3	343.6	297.4	226.4		514	525.7	0
$v_p/c$ ratio, $X$ (Eq. 6.12)	0.047	0.836	0.601	0.363	0.545	0.618	0.184	0.589		0.099	0.378	
Flow ratio, $\gamma = v_p/s$ (Eq. 6.13)	0.013	0.232	0.167	0.067	0.101	0.115	0.025	0.08		0.027	0.105	
Critical lane group/phase (v)												
Sum of flow ratios for critical lane groups, $\gamma_c$												
$\gamma_c = \sum (\text{critical lane group } v/s)$												
Total lost time per cycle, $L(s)$												
Critical flow rate to capacity ratio, $X_c$												
$X_c = (\gamma_c)/(C)/(C-L)$												
Lane Capacity, Control Delay and LOS Determination												
	EB			WB			NB			SB		
	LT	TH	RT	LT	TH	RT	LT	TH	RT	LT	TH	RT
Adjusted flow rate, $^2v_p$ (veh/h)	13	302	345	106	206	213	55	133	63	51	199	57
Lane group capacity, $^2c$ (veh/h)	288.4	361.5	573.5	292.7	378.3	343.6	297.4	226.4		514	525.7	
$v_p/c$ ratio, $^2X = v_p/c$	0.047	0.836	0.601	0.363	0.545	0.618	0.184	0.589		0.099	0.378	
Total green ratio, $^2g/C$	0.278	0.278	0.278	0.185	0.185	0.185	0.136	0.136		0.278	0.278	0.278
Uniform delay, $d_1$ (sec/veh) $d_{1i} = 0.5C [1 - g/C]^2 / \{1 - (g/C)[Min(1, X)]\}$ (Eq. 6.16)	42.8	55.0	50.7	45.3	47.0	47.7	43.3	45.9		43.4	47.2	42.3
Incremental delay calibration, $^3k$	0.50	0.50	0.50	0.50	0.50	0.50	0.50	0.50		0.50	0.50	0.50
Incremental delay, $d_2$ (sec/veh) $d_{2i} = 900T \{ (X-1) + \sqrt{((X-1)^2 + 8kIX/cT)} \}$ (Eq. 6.18)	0.3	20.0	4.6	3.5	5.6	8.1	1.4	10.8		0.4	2.1	
Initial queue delay, $d_3$ (sec/veh) (Eq. 6.19)	0	0	0	0	0	0	0	0		0	0	0
Uniform delay, $d_1$ (s/veh) (Eq. 6.16)	42.81	55.03	50.73	45.29	47	47.71	43.33	45.92		43.44	47.21	42.25
Progression adjustment factor, PF (Table 6.6 or Eq. 6.17)	1	1	1	1	1	1	1	1		1	1	1
Delay, $d = d_1(PF) + d_2 + d_3$ (s/veh) (Eq. 6.15)	43.11	75.01	55.34	48.76	52.55	55.82	44.69	56.69		43.82	49.27	42.25
LOS by lane group (Table 6.5)	D	E	D	D	D	D	D	E		D	D	D
Delay by approach, $d_A$ (sec/veh) $d_A = (\sum [d_i v_i])$ (Eq. 6.20)	64.1			53.1			39.8			47.1		
LOS by approach (Table 6.5)	E			D			D			D		
Approach flow rate, $v_A$ (veh/h) (Table 6.5)	661			525			251			307		
Intersection delay, $d_I$ (sec/veh) $d_I = (\sum [d_A v_A])$ (Eq. 6.21)	54.3			Intersection LOS (Table 6.5)						D		
<b>Notes</b>												
1. For permitted left turns, the minimum capacity is $(1+PL)(3600/C)$												
2. Primary and second to the proportions of turning volumes in the lane group												
3. For permitted or nonactuated signals, $k = 0.50$												
4. $T =$ analysis duration (h); typically $T = 0.25$ which is for the analysis duration of 15 minutes												
$l =$ upstream filtering metering adjustment factor, $l = 1$ isolated intersections.												